Control system

THETA

For the heating specialist
Operating and installation instructions



Room control unit RSC and RSC-OT

Contents

General safety instructions	3
Safety measures for EMC - compliant installation	3
Installation of the room control unit.....	5
Mounting location.....	5
Mounting instructions.....	5
Electrical connection.....	6
Electrical connection at the boiler.....	6
Accessories	7
Outdoor sensor	7
Resistance values of outside sensor	7
Commissioning of the room control unit.....	8
Language.....	8
Code input	8
Alarm messages.....	9
Heating system information	11
Parameter synoptic.....	12
Overview of installer parameters and adjustment options.....	13

General safety instructions

All electrical connections and safety measures have to be carried out by a specialist in due consideration of valid standards and VDE-guidelines as well as the local regulations.

The electrical connection must be a permanent connection in accordance with VDE 0100.

The electrical connection has to be done according to the specifications of the respective boiler manufacturer.

Important!

Deenergize the boiler before opening. Unprofessional plugging attempts under voltage may damage the control or cause dangerous electrical shocks.

Safety measures for EMC - compliant installation

1. Cables with mains voltage must be generally routed separately from sensor lines and data bus cables. A minimum distance of 2 cm between the lines is mandatory. Crossing of lines is permitted.

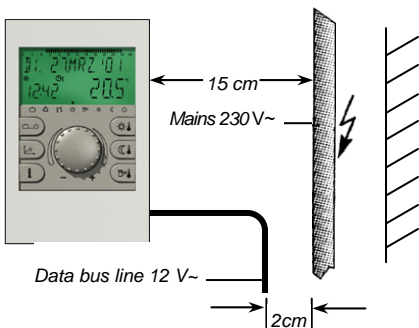

Fig. 1: Minimum distances for electrical connection

2. When installing the room control unit a minimum distance of 40 cm must be maintained to other electrical utilities with electromagnetic emissions, such as power contactors, motors, transformers, dimmer switches, microwave ovens and televisions, loudspeakers, computers, mobile phones etc.

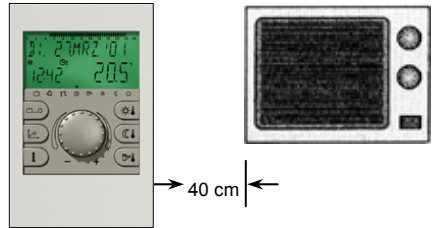

Fig. 2: Minimum distance to other electric instruments

3. The main connection for the heating system (i.e. heat generator - control unit) must be designed as an independent electrical circuit. There should no fluorescent lamps or other machines, which may be sources of disturbance, be connected and even the possibility of such connections should be ruled out.

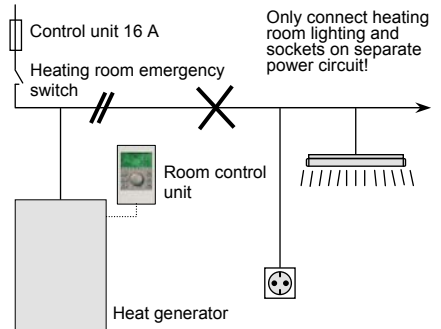

Fig. 3: Electric routing in heating room

- All data bus cables must be carried out in shielded version.
- The shielding of the cable has to be connected with earth potential, i.e. boiler covering, connecting terminals - for earth potential etc. Multiple grounding is not permitted (humming loop).

- The outside sensor may not be installed close to transmitting or receiving equipment (on garage walls close to receivers for radio-controlled garage door openers, amateur radio antennas, radio controlled alert systems or close to large scale radio transmission equipment).

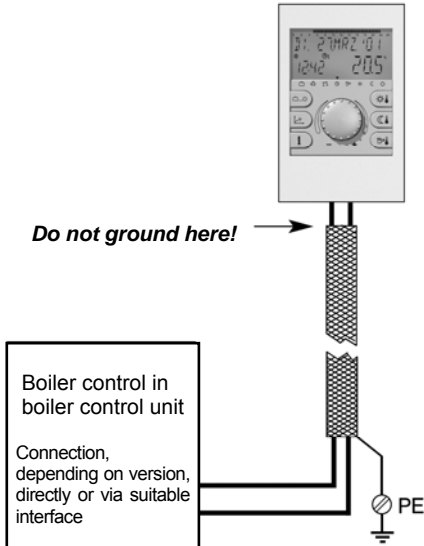

Fig. 4: Screen grounded in centre

In stellate data bus networks shall be no double grounding. The grounding must be made unilaterally in the star-point.

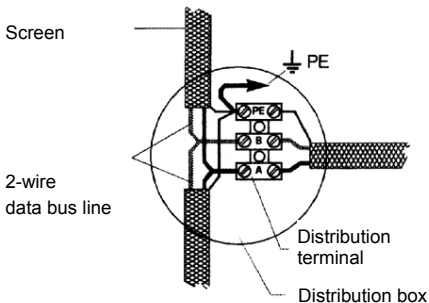

Fig. 5: Grounding in star shaped networks

Recommended cable cross-sections and maximum permitted cable lengths:

A – Sensor lines

For all low voltage cables such as sensors, extern selectors, bus and analogue in- and outputs, heat requiring by means of extern contact, modem connection cables, etc.: 0.5 mm^2

Maximum permitted cable length: 50 m

Longer connecting cables should be avoided in order to reduce the risk of interfering radiation.

B – Data bus lines

Recommended cable:

J-Y(St)Y $1 \times 2 \times 0.6 \text{ mm}^2$

Maximum permitted cable length:

100 m

Longer connecting cables should be avoided in order to reduce the risk of interfering radiation.

Installation of the room control unit



Mounting location

a – for applications without room sensor

If the internal room sensor is not to be activated the unit may be mounted at any location indoors.

b – for applications with room sensor

The activated room sensor should be fixed at a height of approx. 1.20 – 1.50 m at a place most representative of all rooms. It is recommended to choose a partition wall in the coolest day room. In order to ensure sufficient air circulation at the room station, it must be mounted to the wall with a gap inbetween.

The unit must not be mounted:

- at locations subjected to direct solar radiation (consider the position of the sun during winter).
- close to heat-generating appliances, such as televisions, refrigerators, wall lamps, radiators etc.
- on walls with heating or domestic hot water pipes or chimneys behind.

- on non-insulated outside walls
- in corners or wall recesses, shelves or behind curtains (insufficient ventilation)
- close to doors of unheated rooms (influence of low temperatures)
- on unsealed flush-type boxes (influence of external low temperatures due to the chimney effect of installation tubes)
- in rooms with radiators controlled by thermostatic valves (mutual influence).

Mounting instructions

After removing the front panel by pressing the locating lug the wall mounting base can be taken off and mounted at the desired location using the enclosed dowel pins and screws. The data bus line must thereby be routed through the bottom cable gland.

Recommended connecting cable:

J-Y(ST)Y 1 x 2 x 0.6 mm²

Maximum cable length: 100 m

Note:

For new installations, a flush-mounting switch box is recommended to ensure perfect routing of the cable.



↑ Locking log

Electrical connection

The 2-strand data bus cable is connected to terminals A and B of the 2-pole terminal strip on the bottom plate.

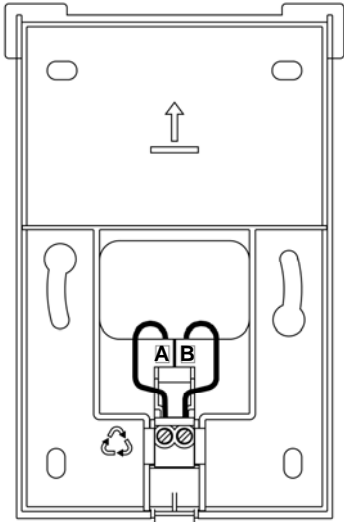

Socket (unit removed)

Electrical connection at the boiler

The electrical connection depends on the type and version of the respective heating generator and takes place directly at the terminals A and B in the corresponding boiler control or interface.

Further detailed information can be found in the documentation for the corresponding boiler.

Important!

The connections are not interchangeable and must be installed in the socket in compliance with the identification A and B.

Once the electrical connection is completed, the room control unit is hooked in flush at the top of the wall mounting base and folded down until the locking lug audibly clicks into the wall mounting base.

Accessories

Outdoor sensor



Outdoor sensor AF 120

Mounting Location

The outdoor sensor should be mounted on the most exposed and coldest side of the building (north or north-east) at a height of min. 2 m above ground.

Exception: If the preferred living area is situated in a different direction, the outside sensor should be mounted on the respective side of the building accordingly.

When mounting the sensor mind external heat sources (heated chimneys, warm hot air from air shafts, installation on black surfaces, thermal bridges in the wall, etc.) which could falsify the measuring value. The cable outlet must always be directed downwards in order to avoid the penetration of moisture.

Installation and electrical connection

- 1– Route the sensor cable to the chosen mounting location.
- 2– Loosen lid screws from sensor case and remove top.
- 3– Mount sensor base with enclosed central fastening screw. Use sealing ring! The cable outlet must be directed downwards!
- 4– Insert the sensor cable so that the cable jacket is fully enclosed by the sealing lip.

- 5– Establish the electrical connection. To this end, preferably use a 2-strand cable with a minimum cross-section of 1 mm². The connection is made at the 2 screw terminals inside the sensor case and may be interchanged.
- 6– Attach the lid again and screw it firmly onto the base. Ensure correct fit of sealing ring.

Resistance values of outside sensor

For outside sensor AF 120:

T (°C)	R (kΩ)
- 20	98,93
- 15	76,02
- 10	58,88
- 5	45,95
± 0	36,13
5	28,60
10	22,88
15	18,30
20	14,77
25	12,00
30	9,804

Note:

If other outside sensors are in use, the respective resistance values, depending on the temperature, can be found in the technical documentation of the boiler manufacturer.

The electrical connection of the respective sensor in the heat generator is described in the respective installation instructions of the heat generator.

Commissioning of the room control unit

Language

During the first activation or with each return of voltage after a power failure all segments available in the display will appear:

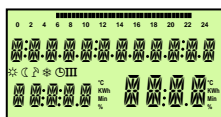

Segment test

The desired language can be selected.

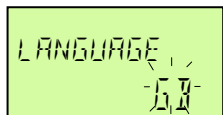

Language

This is followed by the equipment version and the current version number of the software.

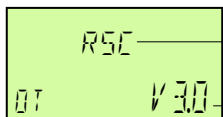

Unit version

Interface version and version number

If there is no alarm present, the standard display with date, time and current heat generator temperature will appear thereafter.



Standard display

Wed. Aug. 25, 2004
16:32 hrs Temp. 40.5°C

An active summer switch-off is identified by a sunshade symbol (☀).

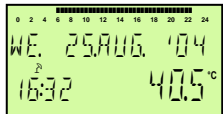

Summer shutdown active

An active frost protection function is represented by a ice crystal symbol (*).



Frost protection active

Code input

Installer code

After entering the installer code all parameters determined for the heating specialist are released and can be edited in accordance with the syst version.

In order to enter the installer code, the keys and must be pressed simultaneously for approx. three seconds, until the code input appears in the display.

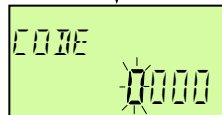
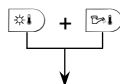

Each flashing digit is set by using the rotary pushbutton in accordance with the code number and is confirmed by pressing the button. All other digits are edited in the same way.

After the code has been entered correctly, the acknowledgement *INSTALLER OK* will appear upon confirmation of the last digit, after a wrong entry, the message *CODE ERROR* will appear.

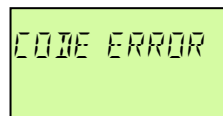
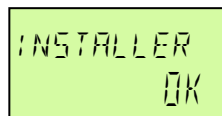

The factory set installer code is :

1 2 3 4

Note: If the code is not accepted you should consult the manufacturer!

Attention: Enabled parameters will be blocked again if no further action takes place over a period of ten minutes. In this case the installer code must be entered again.

Alarm messages

In order to be able to perform an exact diagnose in case of a problem the control system is equipped with a comprehensive fault alarm system. Depending on the nature of the fault a corresponding alarm message will appear in the display of the room control unit.

The display and processing of logic alarms is deactivated in the factory and can be activated in the *SYSTEM* level by enabling Parameter 13 (= Logic alarm). The entry into the level selection and the entry into the levels is shown in the Parameter synoptic (see page 11).

Further processing of errors:

- Errors appear in the standard display of the control
- System errors appear in the info-level at the corresponding info-value
- Errors may be taken over into the error message register (see description opposite).

Detailed information about errors of the heat generator can be found in the documentation of the heat generator.

Alarm messages from boiler control

If boiler controls are used in the respective heat generator, the alarm messages are divided into:

- A - permanent faults (permanent locking) with error code E-XX
- B - temporary faults (self-eliminating locking) with error code B-XX

Fault category A	Locking	E-XX
Fault category B	Blockage	B-XX

Alarm message register

The room control unit is provided with an alarm message register, which is able to hold maximum 20 alarms. The alarms are displayed with date, time, and nature of fault (error number), the errors are polled in the sequence of their occurrence in the level *ALARM*.

The latest (= up-to-date) alarm is prioritized at first position, alarms that have arrived before appear in the order of their occurrence. Upon arrival of a new alarm the last (20.) alarm will be deleted.

Alarm messages from condensing boiler controls represent a special feature. If enabled (*SYSTEM* parameters 27 and 28), these will be written into an own alarm message memory.

There are two different categories of alarm messages:

1X-X Sensor alarm messages

Sensor values that lie outside the measuring range are considered errors. They appear with an error message according to their use.

5X-X Logical alarm messages

These alarm messages evaluate the expected control result. They appear with the corresponding error code, depending on design and assignment.

Table of alarm messages:

Sensors and variable inputs:

Designation	Alarm cause	Code
Outdoor sensor	break	10-0

Display and further processing of logical error messages can be enabled or disabled by using the respective parameterisation in THETA.

Temperatures:

Heat generator	not reached	50-4
DHW	not reached	51-4
Room HC	not reached	54-4

Heating system information

After accessing the information level using the information key , all available plant- and system temperatures can be requested one by one by turning the rotary pushbutton clockwise or counter-clockwise. Entry occurs at the respective outside temperature.

A – Heating system temperatures

If **set value** is displayed in the following table in the category "display value", it will appear when the rotary pushbutton is pushed.

The following displays only appear under the specified display conditions.

INFORMATION	DISPLAY VALUE	DISPLAY CONDITIONS
Outside temperature	Actual value/ Set value = mean value	If outside sensor is connected
Outside temperature	Minimum/maximum value (0.00 to 24.00 h)	If outside sensor is connected
Boiler temperature	Actual value/ set value	
Heat generator return flow temperature	Actual value	If return flow sensor is present
Flue gas temperature	Actual value	If flue gas sensor is present
Hydraulic pressure	Actual value	If pressure sensor is present
DHW / Hot water generator	Actual value/ set value	If hot water generator os present
Room temperature Direct circuit / HC	Actual value/ set value	If room sensor is enabled

B - Operating states

After entering the information level by means of the information key , all available operating states and usage data such as

counter readings, specified performance data etc. can be requested after each other by turning the rotary push-button counter-clockwise.

INFORMATION	DISPLAY VALUE	COMMENTS
Status Direct circuit	<i>AUTO P2 DAY</i> <i>HC ON</i>	Operating mode / ☉-program/ heating mode status of heating pump
Status domestic hot water circuit	<i>AUTO DAY</i> <i>DHW OFF</i>	Operating mode / ☉-program/ heating mode status of heating pump
Status Heat generator	<i>HEAT GENER.</i> <i>ON</i>	switching condition of heat generator (<i>ON/OFF</i>)
Starts Heat generator	<i>STARTS</i> <i>1483</i>	Sum of heat generator starts
Operating hours Heat generator	<i>OPER. HOURS</i> <i>485</i>	Sum of heat generator operating hours
Thermostat function Direct circuit	<i>THERMOSTAT</i> <i>HC OFF</i>	Room thermostat function is active Room temperature limitation currently ON/OFF

Parameter synoptic

Entry into the level selection:



Hold rotary push-button pressed for approx. 3 seconds - automatic call of time programs
Select required level via rotary push-button and confirm, enter code if necessary

Param. No.	Programming		Configuration		Control circuits			ALARM	SENSOR ADJ.
	TIME-DATE	TIMEPRO-GRAMS	HYDRAULIC	SYSTEM	DHW	UNMIXED CIRC	HEAT GENER.		
1	TIME (h/min)	See instructions		LANGUAGE	DHW-NIGHT temperature	RED. HEATING		ERR-1	Room sensor Unmixed circ.
2	YEAR		Output DHW-P	TIME PROGRAM	LEGION. PROT. DAY (week-day)	HEAT.SYSTEM		ERR-2	
3	DAY-MONTH			CONTROL MODE	Legionella protection (time)	Room sensor		ERR-3	
4	CHANGE Su-Wi AUTO			SUMMER (switch-off)	Legionella protection (temperature)	Room effect factor		ERR-4	
5			Output HC	System frost protection		Adaptation heating curve	Boiler set back	ERR-5	
6					DHW max. limit	Inrush Optimization		ERR-6	
7						Heating limit		ERR-7	
8						Room frost protection temperature		ERR-8	
9			Climate zone		Room thermostat function		ERR-9		
10			Building		OT-sensor		ERR-10		
11			Time for automatic exit		Constant control unit		ERR-11		
12					Min-limit heating circuit		ERR-12		
13			Logical error message		Max-limit heating circuit		ERR-13		
14					Excess heat generator		ERR-14		
15							ERR-15		
16					Screed function		ERR-16		
17							ERR-17		
18			Release Cycle temperature				ERR-18		
19			Frost protect.mode Constant/cyclic operation				ERR-19		
20							ERR-20		
21									
22									
23			Anti-blocking protection		Room control P-range				
24			Fahrenheit range		Room control Adaptation time				
25					Operating mode Holiday	Out-lock			
26									
27									
28				RESET to factory values		HC name	RESET Oper.data		

Parameters without background colour: User Parameter, accessible without code

Parameters with light grey background: Installer Parameter, only accessible with installer code

Parameters with dark grey background: Only accessible with installer code and certain settings

Overview of installer parameters and adjustment options

HYDRAULIC Level

The parameters of this level refer to the general hydraulic system of the heating plant as well as to the functionality and configuration of the programmable inputs and outputs for the corresponding plant components.

Parameter	Designation	Setting range / Setting values	Fact. setting	Individual setting
02	DHW – ON / OFF	OFF No function 1 DHW - ON	1	
05	HC – ON / OFF	OFF No function 2 Direct circuit pump 6 Constant control unit	2	

SYSTEM Level

The parameters in this level refer to the general limiting parameters and setting values in the heating system to be used.

Parameter	Designation	Setting range / Setting values	Fact. setting	Individual setting
LANGUAGE	Font language selection	DE German CZ Czech GB English PL Polish FR French RO Romanian IT Italian RU Russian NL Dutch TR Turkish ES Spanish S Swedish PT Portuguese N Norwegian HU Hungarian BG Bulgarian	D	
TIME PROGRAM	Number of enabled time programs	P1 Only one time program enabled (unmarked) P1-P3 Three time programs enabled, (marked)	P1	
CONTROL MODE	Enabling of separate control mode setting	1 Common adjustment for all Heating circuits and DHW 2 Separate adjustment for every individual heating circuit	1	
SUMMER	Limit temperature for summer switch off	OFF no function System frost protection...30 °C	20 °C	
05	System frost protection	OFF no function -20°C...Summer switch-off	3 °C	
09	Climate zone	-20..0.0°C	-12 °C	
10	Type of building	1 light construction 2 medium construction 3 heavy construction	2	
11	Time for automatic exit	OFF No automatic return after adaptation time, autom. return to standard display 0,5..5 (min)	2 min	
13	Logical error message	OFF, ON	OFF	
18	Release cycle temperature	OFF, ON	ON	
19	Frost protection mode	OFF Permafrost protection according to Adj. Param. 5 0,5..60 min cyclic operation	OFF	
23	Lock Code, User Level	OFF (0000), 0001...9999	OFF	
24	Fahrenheit range	OFF (0000), 0001...9999	OFF	
RESET	Reset to factory values	in dependence on access code only to released parameters	-	

DHW level

This level contains all parameters which are necessary to program the DHW circuit with the exception of the DHW time programs.

PARAMETER	Designation	Setting range / Setting values	Fact. setting	Individual setting
DHW NIGHT	DHW economy temperature	5 °C ... DHW night maximum temperature OT OFF ... DHW Day	40 °C	
LEGION.PROT. DAY	DHW legionella protection - day (to enable, select weekday)	OFF No legionella protection Mo...Su Legionella protection on the specified weekday ALL Legionella protection every weekday	OFF	
03	DHW legionella protection - time (only appears if Parameter LEGION.PROT. DAY is enabled)	00:00...23:00 o'clock	02:00	
04	DHW-legionella protection-temp. (only appears if Parameter LEGION.PROT. DAY is enabled)	10°C ¹⁾ ... DHW maximum temperature ¹⁾	65°C ¹⁾	
06	DHW- maximum temperature limit	20°C ¹⁾ ... Heat generator maximum temperature ¹⁾	65°C ¹⁾	

¹⁾ Setting ranges and maximum temperatures, depending on the version, are set by the boiler control

Level UNMIXED CIRCUIT

This level contains all necessary parameters for the programming of the unmixed heating circuit with the exception of the time programs.

PARAMETER	Designation	Setting range / Setting values	Fact. setting	Individual setting
RED. HEATING	Type of reduced operation	ECO - switch-off operation RED - set-back operation	ECO	
HEAT.SYSTEM	Heating system (exponent)	1.00 ... 10.00	1,3	
03	Room temperatur influence (in connection with room sensor)	OFF - without room sensor 1 - room sensor enabled 3 - room sensor only for room-temp-display	OFF	
04	Room effect factor	OFF, 10 ... 500 %, RC (only room control)	OFF	
05	Adaptation heating curve	OFF, ON (not during HC = constant control)	OFF	
06	Inrush optimization	OFF, 1 ... 16 h	OFF	
07	Heating limit	OFF, 0,5...40,0 K (not during HC= constant contr.)	OFF	
08	Room frost protection temperature	5 ... 30 °C	10 °C	
09	Room thermostat function	OFF, 0,5 ... 5 K	OFF	
10	OT-sensor classification	0, 1, 2	0	
11	Constant control unit	10 ... 95°C (only if Par. 05 – Hydraulic =6)	20 °C	

12	Minimum temperature limit	10 °C ... setting Maximum temperature limit (Parameter 13)	20 °C	
13	Maximum temperature limit	Minimum temperature limit (Parameter 12) ... 95 °C	75 °C	
14	Temperature excess heat generator/heating circuits	-5 ... 20 K	0 K	
16	Screed drying function	OFF, 1, 2, 3 (only if funct. SPL = OFF)	OFF	
23*	Room control P-range (K-factor)	1 ... 100 (only if Parameter 4 = RC)	8	
24*	Room control Adaptation time Tn	5 ... 240 (only if Parameter 4 = RC)	35	
25	Operating mode Holiday	STBY, RED	STBY	
HC-name	Heating circuit name	00000 ... ZZZZZ	empty	

* only if remote unit is room controller (PARAMETER 04 = RC)

Level HEAT GENER.

This level contains all parameters which are necessary to program the heating generator.

PARAMETER	Designation	Setting range / Setting values	Fact. setting	Individual setting
05	Limiting mode WE-minimum temperature	1 = Minimum limitation depending on demand 2 = Limited minimum limitation 3 = Unlimited minimum limitation	1	
25	Outside temperature limit	OFF, -20 ... +30	OFF	
31	Reset operation data	SET	-	

Level ALARM MESSAGE

In this level up to 20 alarm messages can be stored, these are permanently updated.

Parameter	Designation	Setting range / Setting values	Fact. setting	Individual setting
01	Alarm message #1	Last alarm message		
02	Alarm message #2	Next to last alarm message		
...		
20	Alarm message #20	First alarm message		

Level SENSOR CALIBRATION

In this level all sensors connected to the central control unit can be corrected by ± 5 K with respect to the factory settings.

PARAMETER	Designation	Setting range / Setting values	Fact. setting	Individual setting
01	Room sensor adaptation	- 5 K ... + 5 K		

Notes