

heatcon!

Short instruction Extension module

heatcon! EM 101

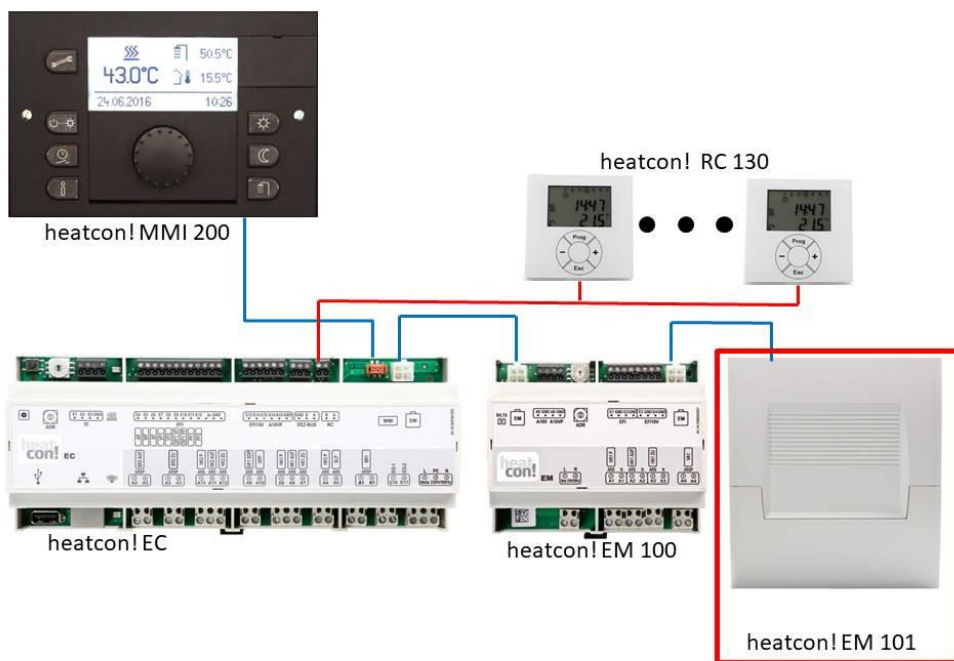

0450000605-1915

GB

Short instruction Extension module heatcon! EM 101

EN Safety instructions



WARNING

Danger due to live parts.

Some components are electrically live. Contact with live parts can result in an electric shock, burns or even death. Before working on the electrical system, observe the following points:

- Switch the system to a zero volts state.
- Secure to prevent switching back on.
- Check for zero volts state.

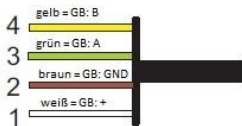
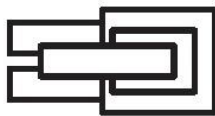
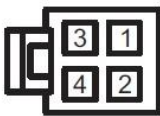
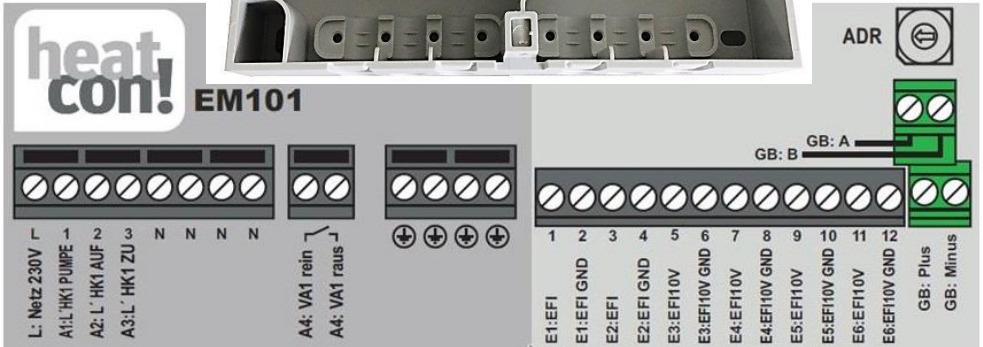

heatcon! EC
heatcon! EM 100

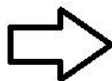

heatcon! EM 101

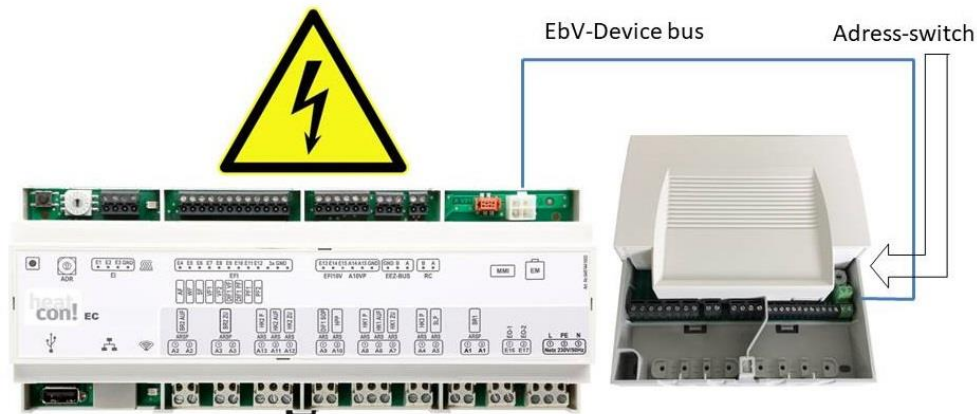

The *heatcon! EM* is an expansion for the inputs and outputs of a *heatcon! EC* inside the system, as shown in the technical data.

Technische Daten

Installation	Wall mounting
Outlets	EbV - Device bus
Connection technology	4-wire technology, screw terminal connection
Maximal zulässige Kabellänge	50 m
Power supply	230 V ±10 %, 50 Hz
Power consumption	max. 9VA
IP class	IP 30
IP rating	IP00
Fusing	User-supplied
Ambient conditions <ul style="list-style-type: none"> • Storage temperature • Operating temperature 	-25 ... +60 °C -10 ... +50 °C
Connections screw terminals	<ul style="list-style-type: none"> • Mains voltage L, N • 1 x potential-free relay ARSP, max. 230V / 2A • 3 x relay 230V ARS, max. 2A, sum current: max. 10A • 2 x sensor pulse input EFI • 2 x sensor pulse 0...10V input EFI 10V • 2 x output 0..10V-PWM A10VP • 2 x EbV – device bus
Standards	DIN EN 60730
Dimensions	145,5 x161 x 48 mm (Länge x Breite x Tiefe)
Weight	405 g
Colour	white



More information you will find:
<https://ebv-gmbh.eu/downloads/>

EN – Warranty conditions

Improper use, non-observation of these instructions, use of inadequately qualified personnel and independent changes exclude any liability on the part of the manufacturer for the resulting damage. The manufacturer's warranty becomes void.

Impairment of device function if incorrect spare parts are used!

If unauthorised parts are used correct functioning is not assured. Use spare parts authorised by customer service.

EN– Declaration of Conformity

EbV Elektronikbau- und Vertriebs-GmbH assures that the product is produced according to valid EU regulations. A complete version of the Declaration of Conformity can be found in the installation manual at <https://ebv-gmbh.eu/downloads/>



Copyright

© Copyright by
EbV
Elektronikbau- und Vertriebs-GmbH
Heisterner Weg 8-12
D-57299 Burbach
Federal Republic of Germany