

Control System **THETA**

Operating Instructions

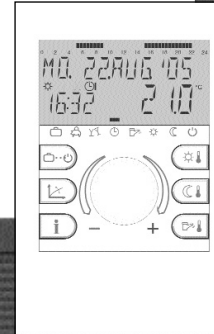

Standard unit
Remote unit
Boiler control panel

Table of contents

Page 2

Display and Controls

Standard unit	3
Remote unit	4

Standard operating modes

Operation - the LCD display - the Standard display	5-6
Temperature settings (required daytime temperature, required reduced temperature, required domestic hot water temperature)	7
Operational mode selection (holiday, absence, party, automatic, summer, permanent heating, permanent reduced heating, standby)	8
Function of operational modes	9
Quick operational mode selection (party, absence, hot-water reloading)	10
Heating curve adjustment	11
Heating system information	12-13

Programming level

Entry into the programming level, programming level synoptic	14-15
--	-------

OPERATING TIMES Programming, block programming of days ,reloading of standard programs, table for individual operating times	16
---	----

SYSTEM Language selection, clearing of time programs, control mode, summer switching off (heating delimiting value)	24
--	----

HOT-WATER Economic temperature, legionella protection (weekday)	27
--	----

HEATING CIRCUITS Unmixed circuit, mixed circuit 1, mixed circuit 2 Reduced mode, heating system	28
---	----

TIME-DATE Time, calender year, calender month, calender day, automatic time changeover mode (summer-/wintertime)	30
---	----

Alarm messages	31
-----------------------------	----

Special operating modes Emission measurement, manual operation, check of safety temperature delimitter (heating specialist only)	32
---	----

Technical specification Standard unit, remote unit	35-36
---	-------

Display and Controls

Standard unit

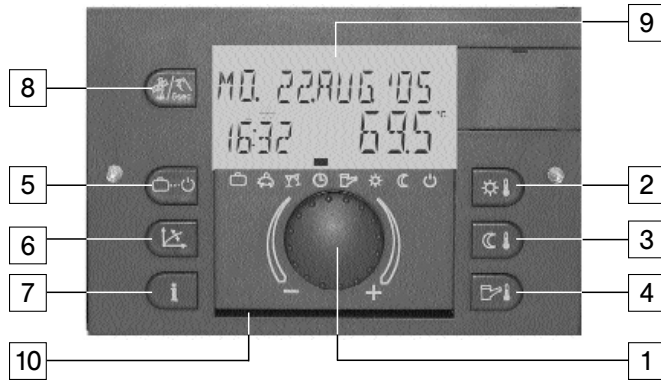

- 1 - Rotary-push button
- 2 - Setting daytime temperature
- 3 - Setting night setback
- 4 - Setting domestic hot water temperature
- 5 - Operating modes button

Remote unit

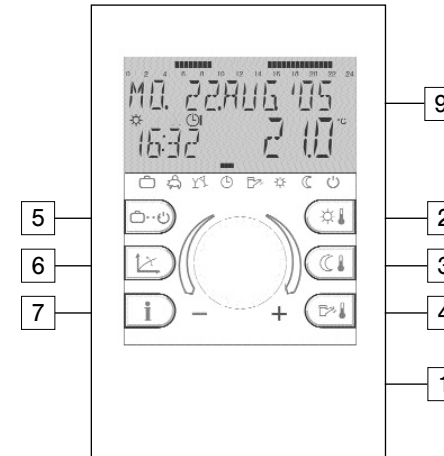

- 6 - Heating curve adjustment
- 7 - Heating System Information
- 8 - Manual mode and emission measurement
- 9 - Backlit LCD display (not in remote unit)
- 10- Operating instructions summary slot

Additionally in the boiler control panel:

Page 4

- 12 - Safety delimiter (LIMITER), accessible behind the hinged cover
- 13 - Fuse, accessible behind the hinged cover
- 14 - Mains switch

Boiler control panel

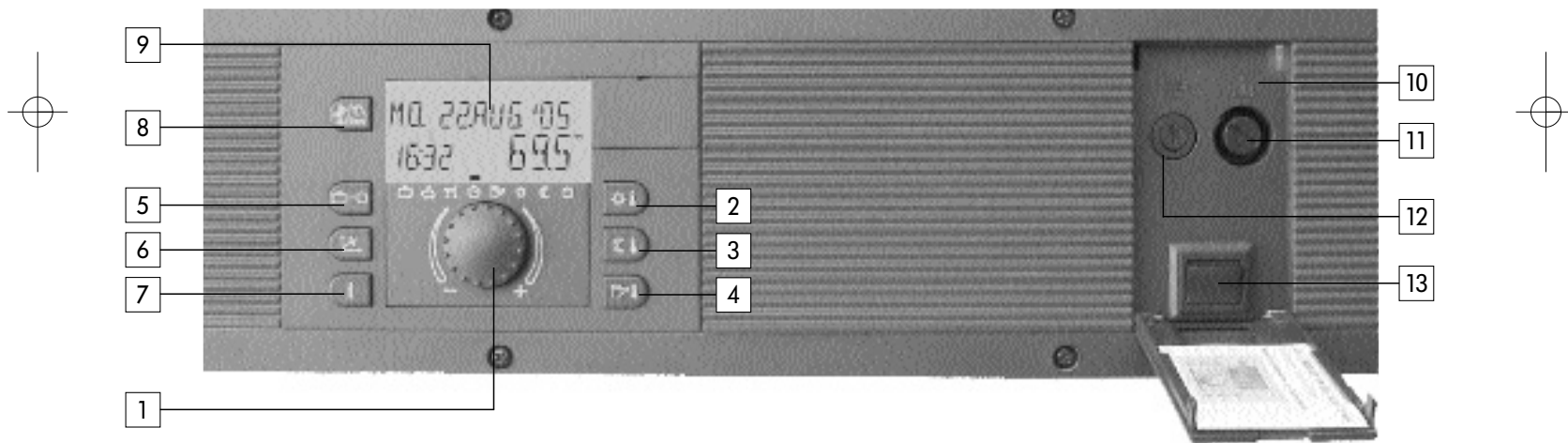

Operation

Symbolism used in this manual:

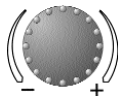

Turn: select parameters, change values



Press once: confirm, store

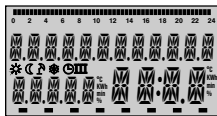

Display test



Language selection

Country code

The center-positioned rotary-push button and the labeled keys guarantee a simple and easy operation. It is however recommended to read this manual attentively to be informed about the repeating steps.

- Each value in the display appears flashing and can be modified with the rotary-push button. A flashing display is appropriately marked in this manual.

Turn to the right (+): Increase values

Turn to the left (-): Decrease values

- Press once: Acceptance of the selected and indicated value, store.
- Keep pressed: Entry into the programming level (level selection),

The last operation step will be stored automatically after approx. 60 seconds if it was not stored by means of the rotary-push button.

Start-up

In case of initiation of the plant or after every power failure a display test of the large display is carried out with automatic error diagnosis. At that all available segments and symbols will be displayed.

Language selection

In case of first initiation the desired language can be chosen after the display test. The languages DE, GB, FR, IT, NL, ES, PT, HU, CZ, PL, RO, RU, TR, S, N, BG can be selected.

Note: This display appears after every restart on day of first initiation until midnight. After that the language can only be changed in the level SYSTEM - parameter LANGUAGE.



Device identification

Interface and software version



Heating cycles

Standard display

Actual boiler temperature resp. room temperature



Standard display

Summer switching-off activated



Standard display

Frost protection activated

Device identification

After the display test and/or the language selection the device identification momentary appears with device type, interface and the corresponding number of software version.

Basic display

Provided that there is not any error message, the basic display indicates the date, time, heating mode (☀ = daytime temperature, ☾ = reduced set back temperature) as well as the current boiler temperature or, if released, the room temperature. Response time program. The cursor below (■) indicates the current operating mode (see function of operating modes). The upper time bar shows the heating periods and the corresponding operating times of the current week-day.

An activated summer switch-off is represented in the basic display by a sunshade symbol (☂). The heating mode symbols ☀ or ☾ will be suppressed during an activated summer switch-off.

With acting frost protection function an ice crystal symbol appears in the basic display (❄).

Temperature settings

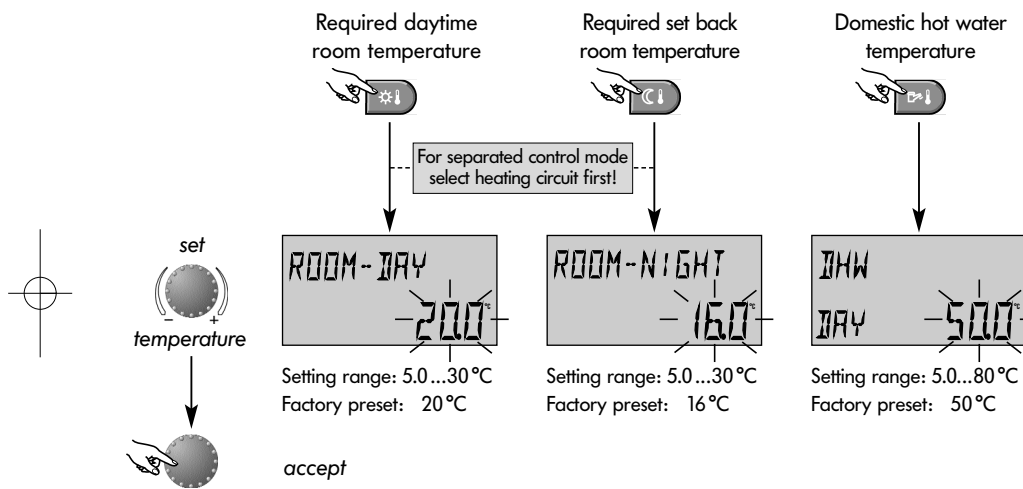

- This button is used to set the required daytime room temperature
- This button is used to set the required set back room temperature
- This button is used to set the required domestic hot water temperature

Adjustment (standard display mode only):
After pressing the button for the required temperature the current value appears flashing and can be adjusted directly with the knob.

For separated control mode the corresponding heating circuit must be selected first before setting daytime or set back temperature.

Re-entry into the standard display is done by pressing the respective button again or automatically after approx. 60 seconds.

Operational mode selection for heating and hot water









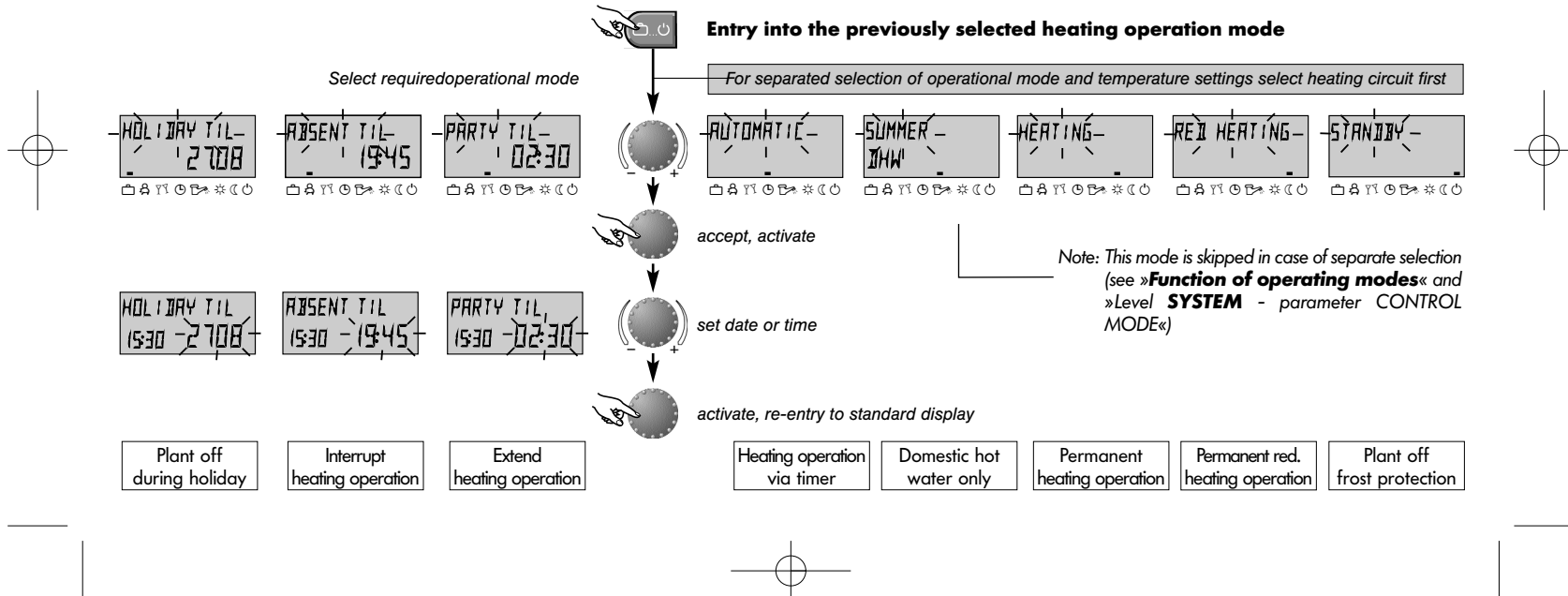

With this button the required operational mode is selected. It appears in plaintext on the display, simultaneously a marker at the lower edge of the display points to the appertaining program symbol. The selected operational mode is valid for all heating circuits (common control mode).

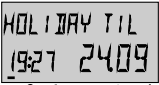
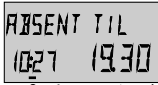
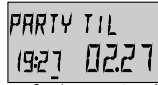
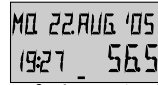
Select: Pressing the button , the previously selected mode appears flashing. The other operational modes can be selected and activated with the knob according to the following scheme.

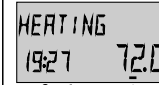
Re-entry to the standard display is done by pressing the rotary-push button or the button  again or automatically after approx. 60 seconds.



Functions of operational modes

Plant off during holiday	Interrupt heating operation	Extend heating operation	Heating operation via timer	Domestic hot water only	Permanent heating operation	Permanent red. heating operation	Plant off frost protection
 <p>HOLIDAY TIL 19:27 24.09</p>	 <p>ABSENT TIL 10:27 19:30</p>	 <p>PARTY TIL 19:27 02:27</p>	 <p>MO 22.AUG '05 19:27 56.5</p>	 <p>SUMMER 10:27 24.0</p>	 <p>HEATING 19:27 72.0</p>	 <p>RED HEATING 19:27 45.0</p>	 <p>STANDBY 19:27 19.0</p>
<p>Setting range: Actual date...actual date + 250 days Return to the previously selected operational mode at 0.00 o'clock of the set return date. Hot water operation is set to frost protection temperature of 5 °C. Earlier termination: Press button , select required operational mode with rotary-push button and press again to activate.</p>	<p>Setting range P1: Heating operation is interrupted until next switching-on time of current operating time program (see level <i>TIME PROGRAMS</i>) 0.5 ... 24h: Heating operation is interrupted until set time of return. Earlier termination: Press button , select required operational mode with rotary-push button and press again to activate.</p>	<p>Setting range: P1: Heating operation is continued until next switching-on time of current operating time program (see level <i>TIME PROGRAMS</i>) 0.5 ... 24h: Heating operation is continued until end of party. Earlier termination: Press button , select required operational mode with rotary-push button and press again to activate.</p>	<p>Operating times: (see level <i>TIME PROGRAMS</i>) Heating and domestic hot water operation automatically according to settings of temperature values (see <i>Temperature settings</i>) and selected operating times program. Programming of individual operating times see level <i>TIME PROGRAMS</i>).</p>	<p>Operating times: (see level <i>TIME PROGRAMS</i>) Only hot water operation according to settings of hot water temperature (see <i>Temperature settings</i>) and selected operating times program. The heating operation is interrupted and frost protected. Programming of individual operating times see level <i>TIME PROGRAMS</i>).</p>	<p>Permanent heating and reduced hot water operation round the clock according to the settings of daytime room temperature and domestic hot water temperature (see <i>Temperature settings</i>)</p>	<p>Permanent reduced heating and reduced hot water operation round the clock according to the settings of set back temperature (see <i>Temperature settings</i>), reduced heating mode (see level <i>HEATING CIRCUITS</i>) and domestic hot water economic temperature (see level <i>DHW</i>).</p>	<p>Heating and hot water plant completely switched off except for frost protection mode.</p>

Quick operational mode selection

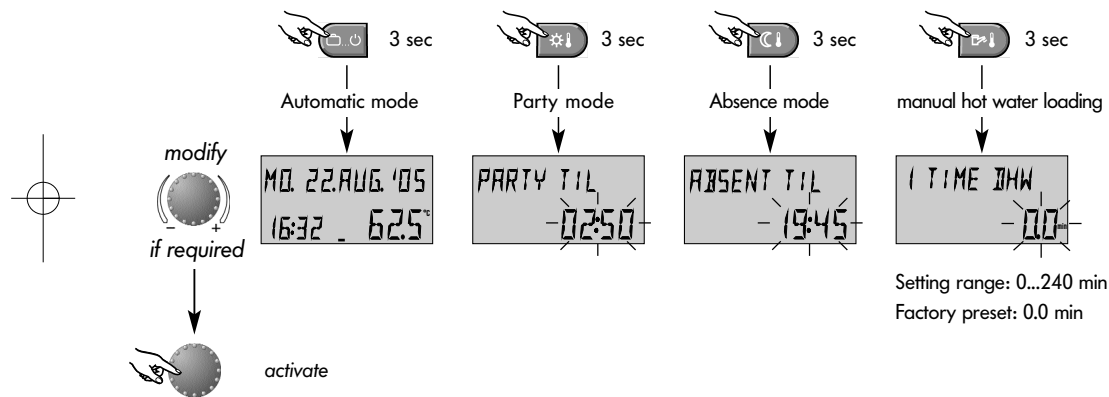

Short-time operational modes

Frequently used operating modes such as *PARTY* or *ABSENCE* or reloading the hot water tank during set back mode can be selected quickly according to the left scheme.

Direct automatic mode

Pressing button for approx. 3 seconds activates the automatic mode via timer inevitably. Functions and setting range see *Operational mode selection for heating and hot water - Function of operational modes*.

Manual hot water loading

To activate manual hot water loading outdoor of operation times the button has to be pressed for about 3 seconds. This turns on hot water preparation at any time for a period which may to be adjusted with the rotary-push button between 0 ...240 minutes. Pushing the rotary-push button activates loading. Afterwards the controller returns to program operation.

At adjustment 0.0 the loading is independent of any time period. The tank will be loaded up to the set DHW-temperature value once.

Heating curve adjustment

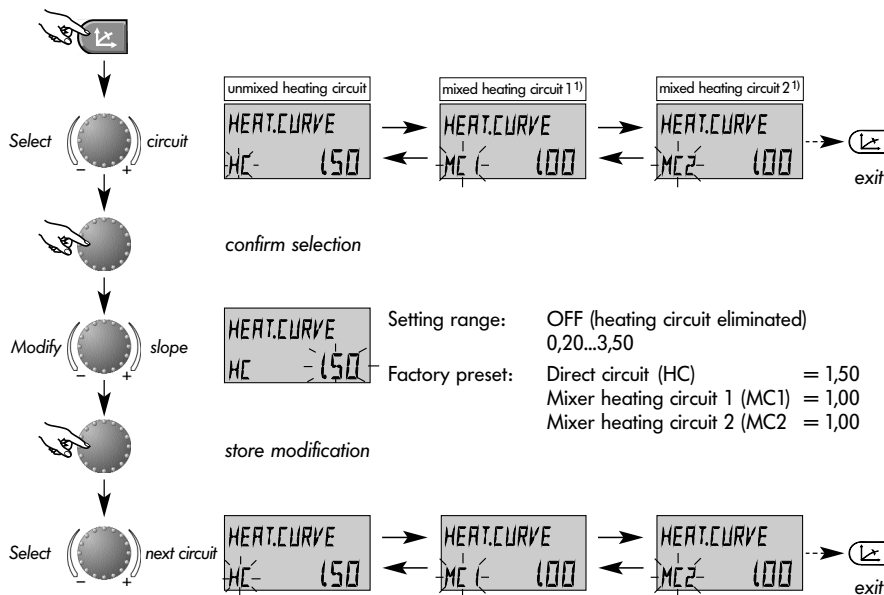

1) only if available in the respective control device





This button regulates the heating characteristics of each heating circuit in relation to the outside temperature.

The adjustment is dependent of the plant installation and shows the relation between outside temperature and heat generator temperature and/or flow temperature.

The slope sets the change of the respective supply temperature, if the outside temperature changes for 1 K.

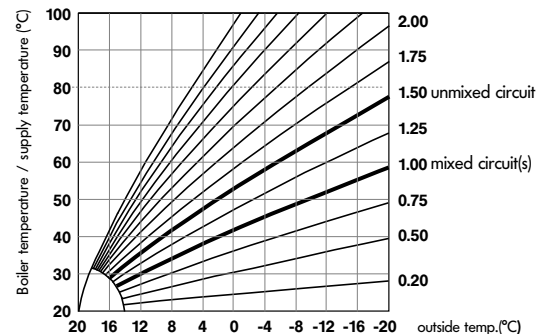
Diagram of heating curves



Re-entry into the standard display is done by pressing the button  again or automatically after approx. 60 seconds.

Heating system information

Page 12

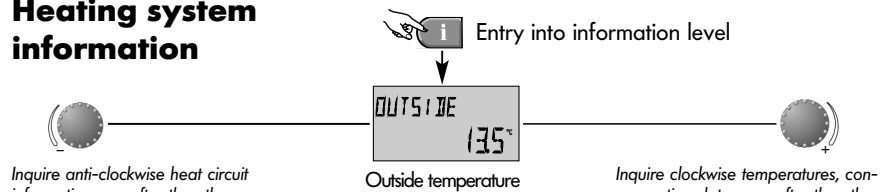

Examples:

AUTO-P1 DAY MC ON	Direct heating circuit 1)
AUTO-P1 REJ MC1 ON	Mixer heating circuit 1 1)
ACTUATOR MC1 STOP	Status of mixing valve 1 1)
AUTO-P1 ECO MC2 ON	Mixer heating circuit 2 1)
ACTUATOR MC2 OPEN	Status of mixing valve 2 1)

Examples:

Outside temperature minimum-maximum value between 0.00h and 24.00h	OUT. MIN/MAX 8.0°C 14.5°C
Boiler temperature	HEAT.GENER 64.5°C
Hot water temperature	DHW 52.0°C
Flow temperature Mixer heating circuit 1	FLOW MC1 48.0°C
Flow temperature Mixer heating circuit 2	FLOW MC2 35.5°C

i The info button displays general information such as boiler water temperatures, and other conditions.

Note: Some information may not appear depending of corresponding control device.

Turn knob clockwise:

- Temperatures (real and nominal values)
- Variable inputs (function and value)
- Meter reading such as consumption data etc.

Turn knob anti-clockwise:

- 1) Heating-circuit information such as
- Type of operational mode (holiday, absent, party, auto, etc.)
 - Timer program P1 (P2 or P3 after clearance)
 - mode of operation (daytime mode, reduced mode, ECO mode)
 - Heating-circuit identification (HC, MC1, MC2, DHW)
 - Status of heating-circuit pumps (ON, OFF)
 - Status of mixing valve (OPEN- STOP- CLOSED)

2) Boiler information such as

- Boiler status (ON, OFF)
- Number of service hours and boiler starts

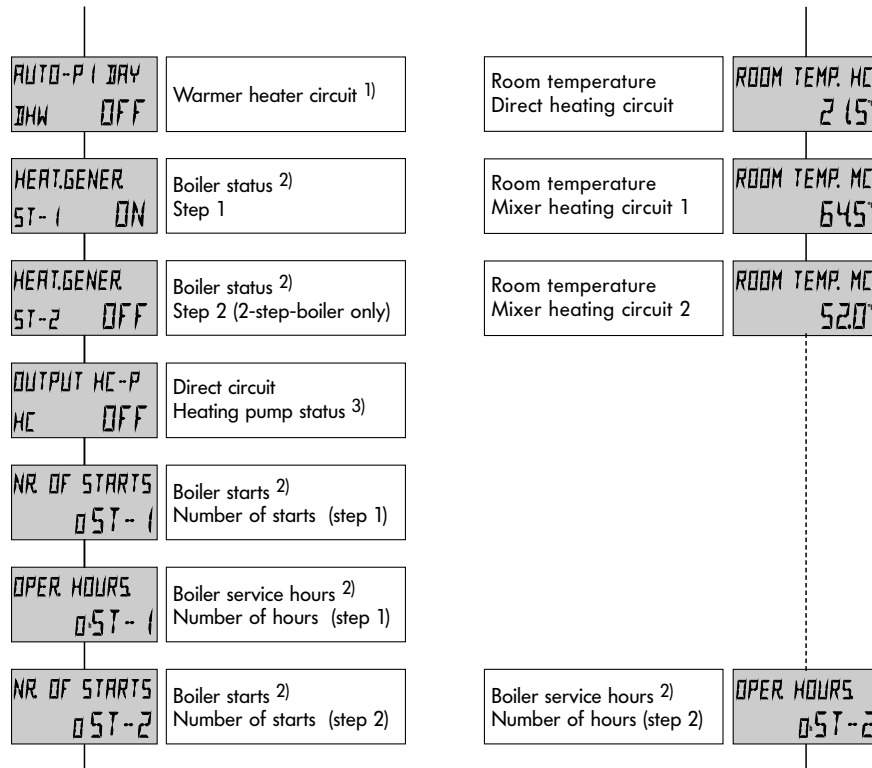

3) Output functions of

- Heating pump of direct circuit (HC-P)
- Variable output VO-1 (depending on control device)
- Variable output VO-2 (depending on control device)
- used as unmixed circuit pump (HC-P), solar pump (SOP), DHW-circulation pump (CIR), electrical heating element (ELH), feeding pump (CHP), boiler circuit pump(s) (BCP-1, BCP-2), alarm message output (EO), return flow pump (RP), Buffer pump (BULP), solid fuel boiler pump (SFP), free timer output (CLOCK), solar change-over valve (SLV), solar forced heat removal valve (SZV), parallel heat generator releasing (PHR), primary pump (PP), hydraulic buffer relief (HBB).

If a control modem is connected, the following operational modes may appear:

- AUTO Automatic
- STBY Standby
- HEAT Permanent heating mode
- RED Permanent set back mode

Displays in some control device temperatures and operational status of multivalent plants in combination with

- solar systems
- buffer storage units
- solid fuel boilers

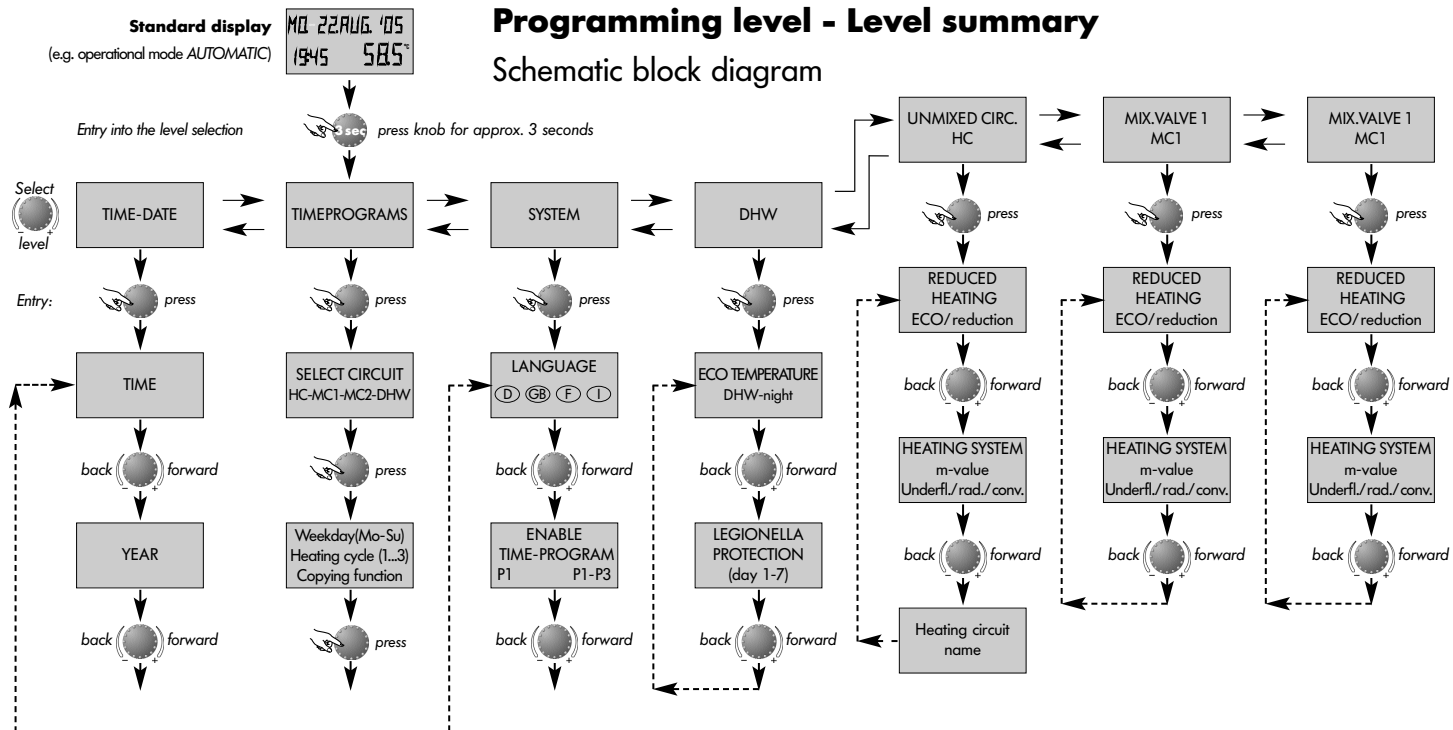

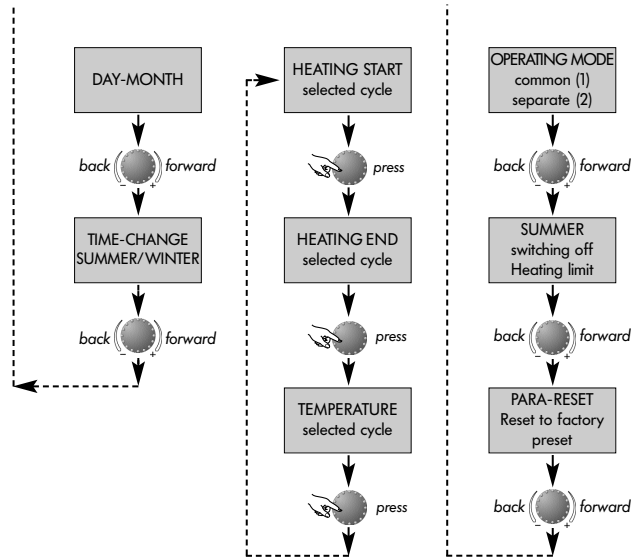



Selection and modification of parameters and setting values

Entering into the programming level, principally the OPERATING-TIMES LEVEL appears at first. All other levels, such as

- DATE/TIME
- SYSTEM
- DHW (DOMESTIC HOT WATER CIRCUIT)
- UNMIXED CIRCUIT
- MIXING VALVE-1 (= MIXER HEATING CIRCUIT-1)
- MIXING VALVE-2 (= MIXER HEATING CIRCUIT-2)

can be selected directly via the rotary-push button.

By pressing the rotary-push button, the selected flashing level is activated; the first value resp. parameter appears flashing. If necessary, it can be modified via the rotary-push button and confirmed by pressing again. If necessary the following parameters can be handled in the same manner.

Re-entry into the level selection is done via the info button , re-entry into the standard display via the program-selection button  or automatically after approx. 60 seconds.

Programming of operating times

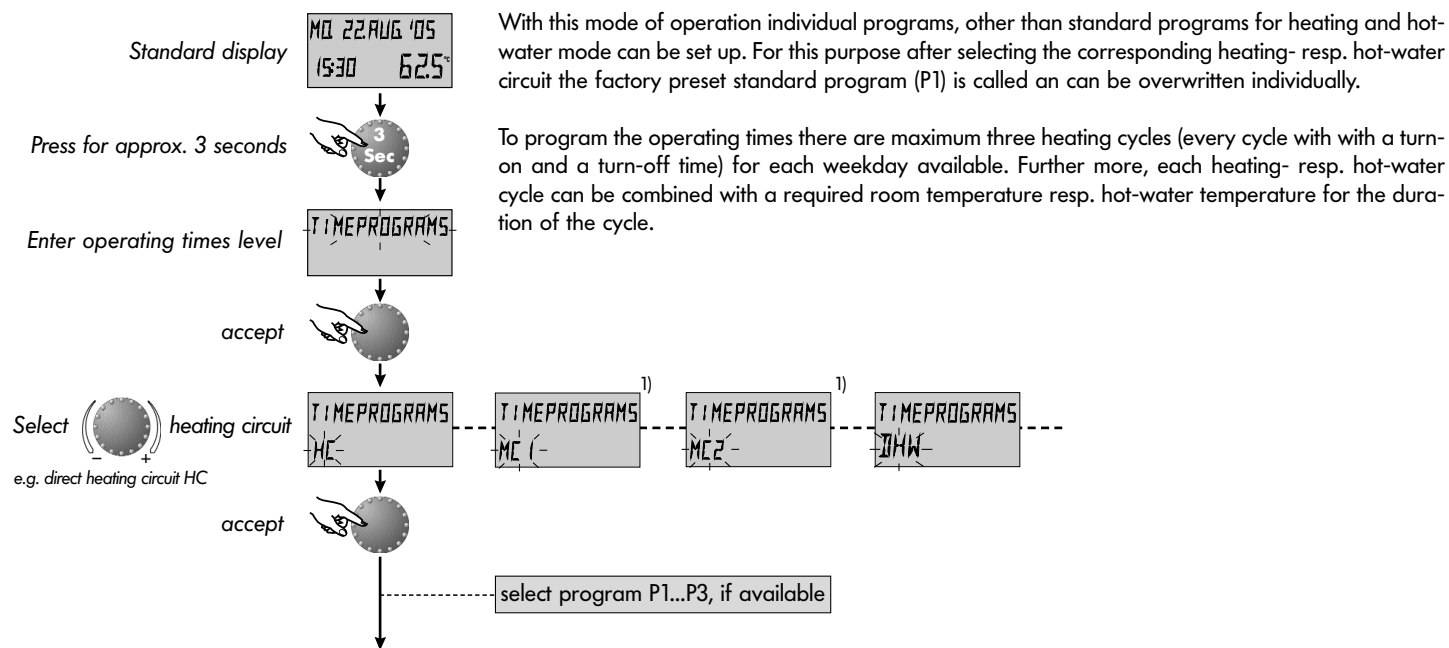

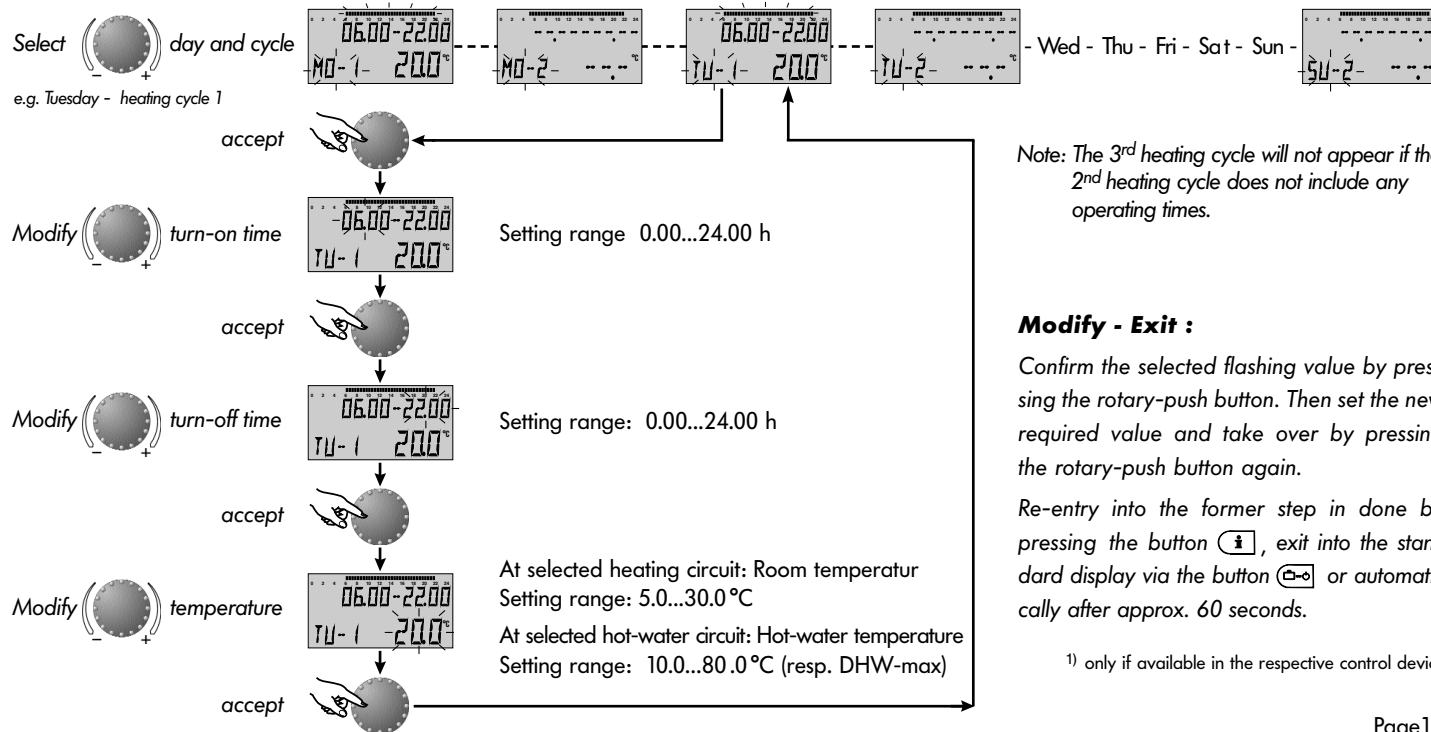

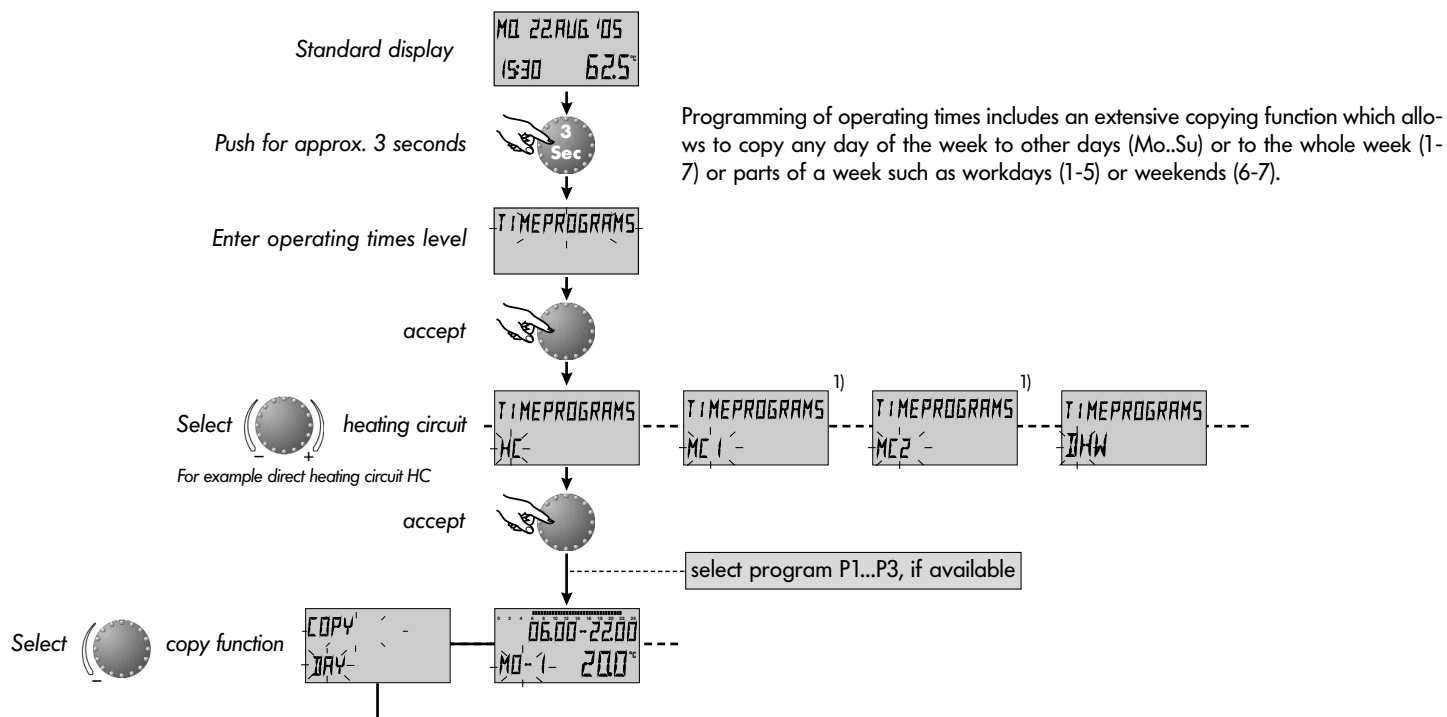

Copy operating times

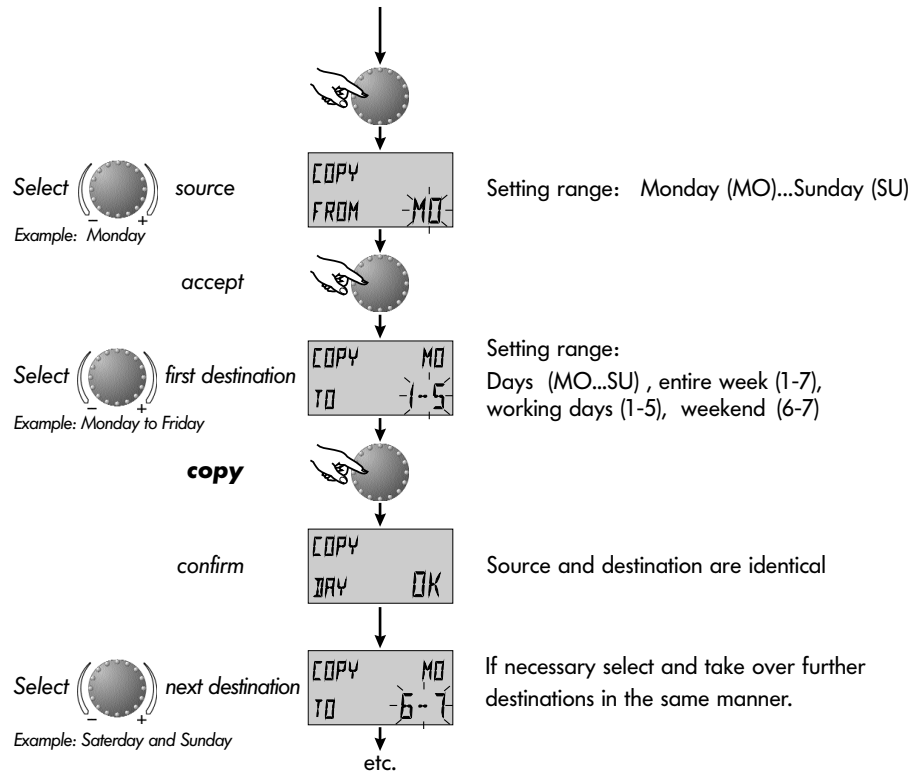



Modify - Exit :

Confirm the selected flashing value by pressing the rotary-push button. Then set the new required value and take over by pressing the rotary-push button again.

Re-entry into the former step in done by pressing the button , exit into the standard display via the button  or automatically after approx. 60 seconds.

¹⁾ only if available in the respective control device

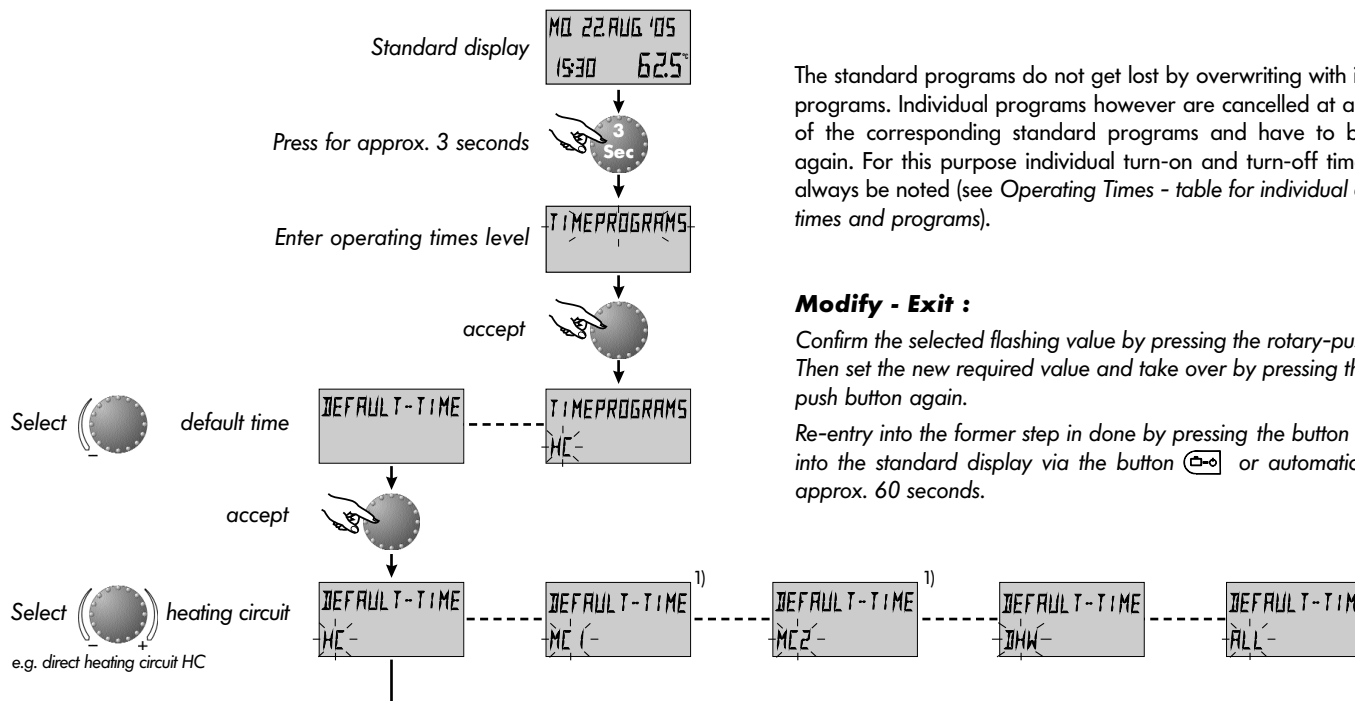

Return loading of standard programs - deleting of individual operating-times programs



The standard programs do not get lost by overwriting with individual programs. Individual programs however are cancelled at a later call of the corresponding standard programs and have to be set up again. For this purpose individual turn-on and turn-off times should always be noted (see *Operating Times - table for individual operating times and programs*).

Modify - Exit :

Confirm the selected flashing value by pressing the rotary-push button. Then set the new required value and take over by pressing the rotary-push button again.

Re-entry into the former step is done by pressing the button , exit into the standard display via the button  or automatically after approx. 60 seconds.

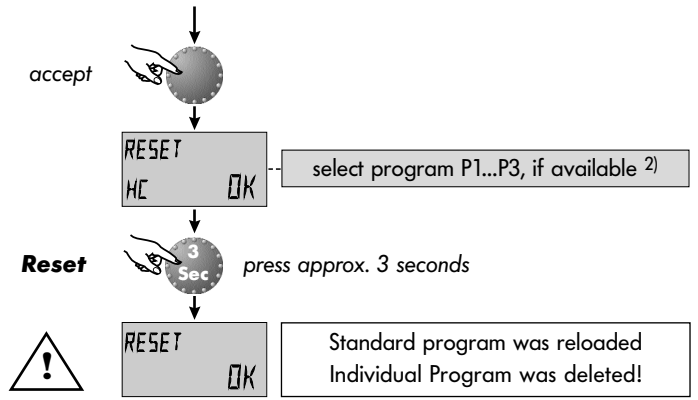

1) only if available in the respective control device

2) see level SYSTEM - parameter PROGRAM

Standard time programs

Standard operating-times program P1

Circuit	Day	Heating from...till
All heating circuits (HC, MC1, MC2)	Mo-Su	06.00 - 22.00 h
Domestic hot water (DHW)	Mo-Su	05.00 - 22.00 h

Standard operating-times program P1 ²⁾

Circuit	Day	Heating from...till
All heating circuits (HC, MC1, MC2)	Mo-Th	06.00-08.00 16.00-22.00h
	Fr	06.00-08.00 13.00-22.00h
	Sa-Su	07.00-23.00h
Domestic hot water (DHW)	Mo-Th	05.00-08.00 15.30-22.00h
	Fr	05.00-08.00 12.30-22.00h
	Sa-Su	06.00-23.00h

Standard operating-times program P3 ²⁾

Circuit	Day	Heating from...till
All heating circuits (HC, MC1, MC2)	Mo-Fr	07.00-18.00 h
	Sa-Su	reduced heating
Domestic hot water (DHW)	Mo-Fr	06.00-18.00 h
	Sa-Su	reduced heating

Table for individual operating times and programs

Direct heating circuit (HC)	Operating times program P1						Operating times program P2						Operating times program P3					
	1 st cycle		2 nd cycle		3 rd cycle		1 st cycle		2 nd cycle		3 rd cycle		1 st cycle		2 nd cycle		3 rd cycle	
	From	till	from	till	from	till	from	till	from	till	from	till	from	till	from	till	from	till
Mon																		
Tue																		
Wed																		
Thu																		
Fri																		
Sat																		
Sun																		

Domestic hot water circuit (DHW)	1 st cycle		2 nd cycle		3 rd cycle		1 st cycle		2 nd cycle		3 rd cycle		1 st cycle		2 nd cycle		3 rd cycle	
	from	till	from	till	from	till	from	till	from	till	from	till	from	till	from	till	from	till
	Mon																	
Tue																		
Wed																		
Thu																		
Fri																		
Sat																		
Sun																		

	Operating times program P1						Operating times program P2						Operating times program P3						
	1 st cycle		2 nd cycle		3 rd cycle		1 st cycle		2 nd cycle		3 rd cycle		1 st cycle		2 nd cycle		3 rd cycle		
	From	till	from	till	from	till	from	till	from	till	from	till	from	till	from	till	from	till	
Mixer heating circuit 1 (MC1)	Day																		
	Mon																		
	Tue																		
	Wed																		
	Thu																		
	Fri																		
	Sat																		
	Sun																		
Mixer heating circuit 2 (MC2)	Day																		
	Mon																		
	Tue																		
	Wed																		
	Thu																		
	Fri																		
	Sat																		
	Sun																		

SYSTEM

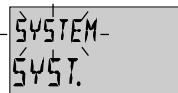

Entry:



next parameter



next parameter



This level includes general delimiting parameters and options referring to the corresponding heating system

Language

Setting range:

DE = German	GB = English	FR = French
IT = Italian	NL = Dutch	ES = Spanish
PT = Portuguese	HU = Hungarian	CZ = Czech
PL = Polish	RO = Romanian	RU = Russian
TR = Turkish	S = Swedish	N = Norwegian

BG = Bulgarian

Factory preset: DE

All information that appears in the display, is available in a number of languages. After entry as first parameter appears the language selection. The required language can be selected according to the above assignment.

Operating times program

Setting range: P1, P1-P3

Factory preset: P1

This parameter specifies the number of the released time programs. With setting P1 only one operating-times program is available, with setting P1-P3 all three programs are released and can be selected for programming operating times.

Entry: see » Programming level - Level summary « .

Exit: via button  or automatically after 60 seconds

Modify: Confirm selected flashing parameter by pressing the rotary-push button. Then set the new required value via the rotary push button and accept by pressing the rotary-push button again.

If necessary, correct the following parameters in the same manner.

Application: Use of the control device in the corresponding language area.

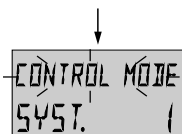

Application: Shift work, different programs for summer, transition period, winter etc.



Control mode

Setting range: 1 = common mode 2 = separated mode
 Factory preset: 1

Common control mode:

The selected operational mode (via button ) for *Holiday, Absence, Party, Automatic* etc.) as well as the temperature settings of day time temperature (via button ) and night set back temperature (via button ) applies to all heating circuits together.

Application: Buildings with single occupancy for heating and hot water

next parameter

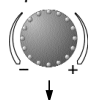

Separated control mode:

Each heating circuit can be assigned with its own operational mode and temperature settings. With separated mode all regulations refer also only to the **previously selected heating circuit** as shown below.

Application: Buildings with multiple occupancy for heating and hot water

Note: In combination with one or more room stations this mode is automatically activated!

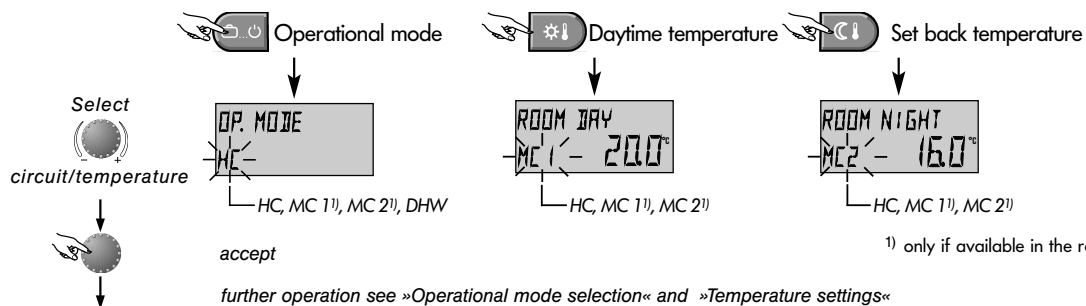



Summer switch-off

Setting range: OFF, 10.0 °C to 30.0 °C
 Factory preset: 20.0 °C

next parameter

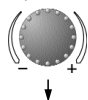

This parameter specifies the heating delimiting value regarding the outside temperature and puts the heating system automatically out of operation as soon as the outside temperature exceeds the setpoint. During summer switch-off all disabled pumps and closed mixing valves are activated every day for approx. 10 seconds to protect them against corrosion.

With setting OFF the summer switch-off is not effective.

Hot water preparation is not affected by summer switch-off.

Note: The active summer switch-off appears in the standard display with a sunshade symbol.

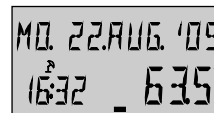

Summer switch-off activated

Application: All buildings which do not require a heating operation during summertime



Parameter-reset

This function resets all individually entered values in the programming level to the factory preset.

Exception: Time-date, operating times

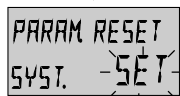
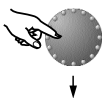

Reset: Press rotary-push button for approx. 5 sec. while indication SET is flashing, until standard display appears.

Important: Reset may only be executed if all individually entered values shall be replaced by the factory preset values!



DOMESTIC HOT WATER



This level includes the necessary parameters for programming the hot-water circuit with the exception of hot-water operating-times.

Entry:

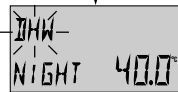

Hot-water economic temperature

Setting range: 5.0 °C up to the selected hot water temperature
Factory preset: 40.0 °C

This parameter determines the amount of the reduced hot-water temperature outside the hot-water operating times (between the hot-water cycles) as well as in the operational mode ABSENCE for the duration of absence.

next parameter



Legionella protection (day)

Setting range: OFF, MO...SU, ALL
Factory preset: OFF

The legionella protection serves to avoid a legionella infestation inside the hot-water tank and is activated on the selected weekday (Mon to Sun) or every day (ALL) at 2.00 o'clock. If the hot-water temperature should drop below 65 °C, the tank is reloaded. With setting OFF this function is not effective.

Entry: see » Programming level - Level summary « .
Exit: via button  or automatically after 60 seconds

Modify: Confirm selected flashing parameter by pressing the rotary-push button. Then set the new required value via the rotary push button and accept by pressing the rotary-push button again.

If necessary, correct the following parameters in the same manner.

Application: Base temperature inside the hot-water tank in order to avoid a cooling down of the tank.

Note: This parameter is skipped if a hot-water thermostat is used instead of an electronic hot-water sensor.

Note: Other times for legionella protection can be programmed exclusively by the heating plant specialist.

Important: Danger of scalding! Use thermostatic mixing valve on DHW outlet.

Unmixed circuit, mixed circuit 1¹⁾, mixed circuit 2¹⁾

UNMIXED CIRC.
HC

This level includes the parameters required for programming the heating circuits with the exception of the related operating-times programs.

Note: The described parameters are related to the direct (unmixed) heating circuit and are equally valid for the mixer heating circuit 1¹⁾ the mixer heating circuit 2¹⁾.

REHEATING
HC ECO

Reduced heating mode

Setting range: ECO, RED

Factory preset: ECO

During the reduced operation the following modes can be selected:

ECO mode: At outside temperatures above the frost protection setpoint the heating circuit is switched off completely. At outside temperatures below frost protection the heating circuit is controlled with reduced heating characteristic according to the required reduced temperature (see »Temperature setting«).

RED mode: During the reduced mode the heating circuit pump remains activated. The heating circuit is controlled according to the reduced heating characteristic, the temperature does not drop below the minimum temperature setpoint.

Entry: see » Programming level - Level summary « .

Exit: via button or automatically after 60 seconds

Modify: Confirm selected flashing parameter by pressing the rotary-push button. Then set the new required value via the rotary push button and accept by pressing the rotary-push button again.

If necessary, correct the following parameters in the same manner.

Application: Buildings with high insulation characteristics

Application: Buildings with low insulation characteristics

next parameter



¹⁾ only if available in the respective control device

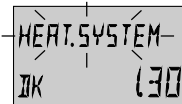

Adaptation to the heating system

Setting range: 1,00 to 10.0
Factory preset: 1,30

This parameter refers to the type of the heating system and has to be adapted to the power characteristic of the corresponding consumer (underfloor systems, radiator, convector). The setting value specifies the curvature of the heating curve of the selected weather dependent heating circuit and compensates the system-related efficiency losses at lower temperatures by a progressive heating curve in conformity with the adjustment.

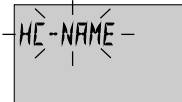

Heating circuit name

This is used to assign an individual, 5 character, abbreviated name to each heating circuit. No individual name is assigned if the setting "empty" is used. The default abbreviated name appears.

- The character that blinks can be altered using the rotary knob according to the code number and accepted by pressing the knob once. The remaining characters can be altered in the same way.
- The individual heating circuit name display appears
 - in the menu
 - in the parameter tree
 - in the info level

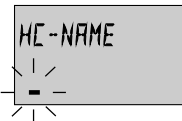

Applications:

The following setting values are recommended for the below-mentioned applications

Setting value	Application
1.00... 1.10	Heating curve for underfloor heating systems or other static heating surfaces
1.30... 2.20	Normal standard heating curves for radiators
3.00... 4.00	Heating curves for convectors
4.00... 10.0	Special heating curves for ventilators with high starting temperatures

TIME-DATE

Page 30

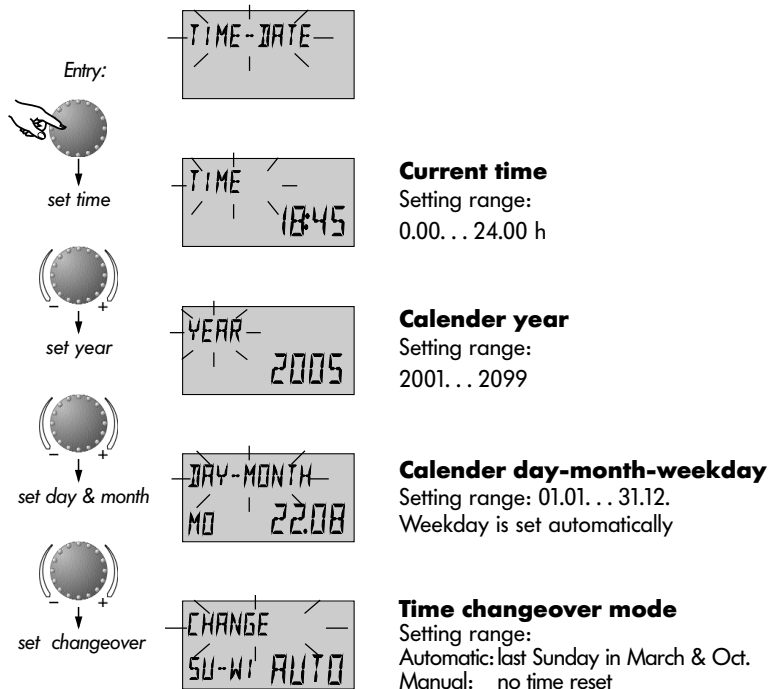

Entry: see » Programming level - Level summary « .

Exit: via button  or automatically after 60 seconds

Modify: Confirm selected flashing parameter by pressing the rotary-push button. Then set the new required value via the rotary push button and accept by pressing the rotary-push button again.
If necessary, correct the following parameters in the same manner.

The values to the left are factory presets and normally need not be updated. If in some exceptional cases corrections should be necessary, the values can be adapted to the real conditions.

The internal pre-programmed calendar provides an automatic time changeover at the yearly repeating summer-wintertime dates.

If required, the automatic time changeover can be switched off (manual reset).

Alarm messages



FLOW
ERROR 12-0

Example for alarm messages »sensor« (short or open circuit)
Error code 10...20



HEAT GEN
ERROR 30-2

Example for alarm messages »boiler« (control status)
Error code 30...40



DHW
ERROR 50-4

Example for logical alarm messages (control functions)
Error code 50...60



BUS
ERROR 70-1

Example for alarm messages »data bus« (address error)
Error code 70

The control device is equipped with an extensive error diagnosis. Alarm messages are displayed primary and may vary dependent on the type of control.

Note: Alarm messages only appear alternating with the standard display.



In case of alarm messages the heating specialist has to be informed unconditionally!

Special operating modes

Page 32

Emission measurement (only available in standard units and boiler control panels)

Only in case of flue cleansing

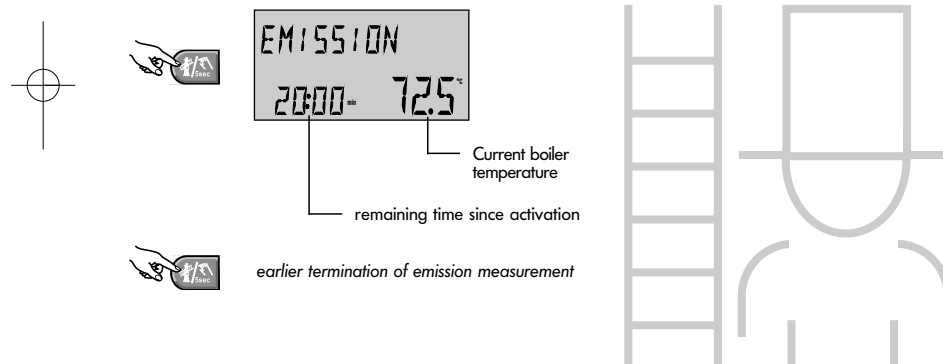

This button shows emission measurement and is used when flue cleansing is required.

When pressed, all circuits operate at their maximum preset temperature for 20 minutes. After this time the emission measurement can be activated again.

The remaining time appears in the display during the whole measurement.

Emission measurement can be terminated at any time by pressing button .

Attention: The domestic hot water tank is charged to the preset maximum hot-water temperature. **Caution!** Danger of scalding on high temperature settings!



Manual mode (only available in standard units and boiler control panels)

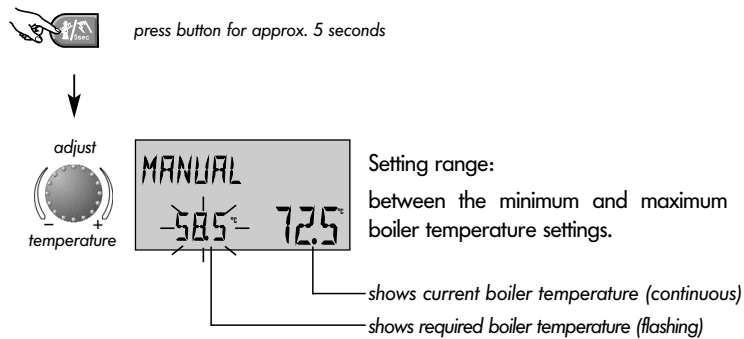

Termination:

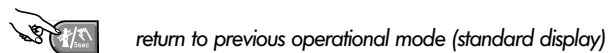



Continues heating and hot-water operation in case of emergency. The heating specialist must be informed.

When the button is pressed for more than 5 seconds while showing the standard display, the control unit is switched over to manual mode. All control functions are released, the required boiler temperature can be adjusted by the rotary-push button. The pumps of all circuits including the hot-water circuit remain in operation. Mixer controls become disengaged so that the mixing valves can be manually adjusted as required.

To return to the previous selected program press button .

Caution!

-  - In manual mode the domestic hot-water temperature can reach scalding temperatures!
-  - Take the relevant security measures to protect underfloor heating systems against overheating (e.g. switching off the circulation pump via external flow thermostat).

Safety check (only available in standard units and boiler control panels)

For the heating specialist only !

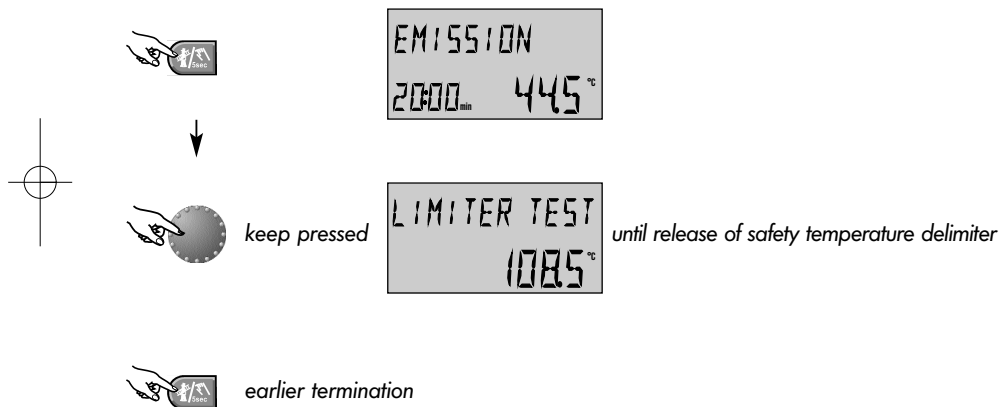

Checking the safety temperature delimiter



The safety check may only be carried out by the heating specialist or other authorized personal.

By pressing constantly the rotary-push button during the emission measurement the integrated boiler temperature delimiter is avoided and the boiler absolutely remains in operation until release of the safety temperature delimiter (STB). The indication on the display changes immediately to

LIMITER TEST

During the safety check all mixers are closed and all pumps are switched off.

Releasing the rotary-push button will immediately interrupt the safety check. Emission measurement continues if the remaining time has not yet elapsed.

The safety check can be terminated any time by pressing button .

Technical specification for standard unit and boiler control panel

Mains voltage:	230 V~ +6/-10%
Nominal frequency:	50 - 60 Hz
Power consumption:	5,8 VA max.
Bus interface:	T2B to connect external instruments such as remote units, personal computers, modems or other gateways, dependig on typ of device with heat generator interface
Overvoltage category	III with mains connection, II bei relay connection
Providing earthing	PE only with boiler control panels
Ambient temperature:	0...60 °C
Storage temperature:	-25...60 °C
Protection type to EN 60529:	IP 40
Protection class acc. to EN 60730:	Standard unit = II, boiler control panel = III
Software-class:	A
EMV- protection:	EN 60730 EMV
Resistance to disturbances:	EN 60730
EC conformity:	89/336/EWG
Action:	Typ 1.C
Degree of pollution	2
Casing dimensions (BxHxD):	Standard unit 144 x 96 x 75 mm - boiler control panel without connectors 405x 128x 80
Casing material:	ABS, antistatic, hardly inflammable
Temperatur of ball pressure test	+ 125°C
Electrical connections:	Standard unit with plug-in screw terminals - boiler control panel with plug-in »Rast-5« -coded terminals
Nominal current:	6 A
Mains fuse:	6,3 A time-lag
Boiler temperature controller:	Integrated, adjustable from minimum to maximum boiler temperature

Technical specification for remote unit

Supply voltage:	Via data bus (DC-safety voltage by EN 60730)
Power consumption:	300 mW
Bus interface:	T2B
Ambient temperature:	0...60 °C
Storage temperature:	-25...60 °C
Protection type acc. to EN 60529:	IP 30
Protection class acc. to EN 60730:	III
Casing dimensions (BxHxD):	90 x 138 x 28 mm
Casing material:	ABS, antistatic
Electrical connections:	2-wire mode with plugable connection
Recommended cable:	J-Y(St)Y 2x2x0.6 mm ²
Maximum length of cable:	50 m
Data storage:	Min. 5 years from date of delivery
Accuracy of the internal clock	± 2s/day
Weight:	Approx. 150 g

Art. 0450017000 - 1010-30

Subject to change