

Operating manual

CETA 106

Heating circuit controller with
differential temperature control

Version 1308-22
Art. 0450021017

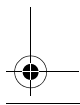
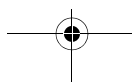
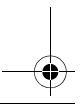



Contents

Scope of delivery	1
General	1
Intended use	1
Safety	1
General key functions	2
Version display (when starting)	2
Basic display	3
Functions with direct access	4
Menu level	5
Parameter description	8
Installation	17
Terminal diagram	18
Fault clearance	19
Sensor resistance values	20
Technical data	22
Liability	22
Disposal	22

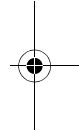
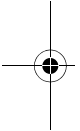

© Elektronikbau- und Vertriebs GmbH

Heisterner Weg 8 - 12

D-57299 Burbach

This document may not be reproduced nor disclosed to third parties, particularly competitors, in original or copy form without our prior explicit consent. The document is subject to our proprietary rights and copyrights.

Any misuse is an infringement of the German Copyright Law of September 9, 1965, the law against unfair competition, and the German Civil Code.

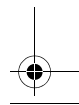
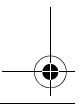

Scope of delivery

- | | |
|------------------------------|------------------------------|
| 1. 1x Central unit CETA 106 | 5. 3x Screw assembly 4x35 mm |
| 2. 1 x Outside sensor AF200 | 6. 3x Plug U6 |
| 3. 1x Flow sensor VF202B | 7. 2 x Cable clamp |
| 4. 8x Screw, plate 2,9x19 mm | |

General

Systems with mixed heating circuit are controlled via the heating circuit controller. Required heating circuit temperature is determined in the flow, depending on outside temperature.

Systems with heat source and hot water tank are controlled via the differential temperature controller (differential sensor not included in delivery). When the heat source temperature exceeds the tank temperature by the value set on the controller, the circulation pump is activated by the control and the heat absorbed in the heat source is transported to the hot water tank.

Intended use

The unit is manufactured in accordance with state of the art technology and approved safety regulations. Nevertheless, using the unit can cause danger to the user or third persons, or damage to the unit and other assets. The unit must be used exclusively as heating circuit controller or differential temperature controller.

Safety

All electrical connections, safety measures and protections have to be carried out by an authorised professional electrician according to the valid standards and VDE-guidelines, as well as the local regulations. The electrical connection must be a fixed connection according to VDE 0100.

Hazard symbols in this operating manual



Hazard!

This symbol indicates information that warns of possible safety risks or severe and fatal injuries!

General key functions

1. General key functions

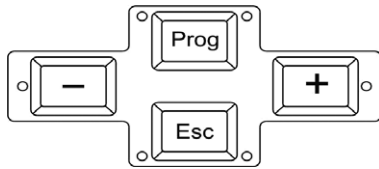

Prog

- Change selected submenus
- Change (parameter) setting
- Save value

+ (Plus) or - (Minus)

- Change parameter
- Change menu item

Esc

- Exit setting
- Keep old value
- Select next higher menu level

Esc-Lang

- Return to basic display

2. Version display (when starting)





c 106= Type designation Ceta 106

1.5= Version display (due to update it can differ from example shown)



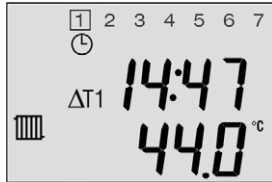



Basic display

3. Basic display



- 1 Weekday
- 14:47 Time
-  Display pump function heating circuit
- 44.0°C Temperature F1 heat storage tank 1 (optional)
- $\Delta T1$ Display pump function ΔT (optional)
-  Automatic mode heating circuit after timer program I and II

Explanation of symbols

-  Display pump function heating circuit
-  Automatic mode heating circuit after timer program I or II
-  Heating mode heating circuit (Operating mode AUTOMATIC or HEATING)
-  Reduced mode heating circuit (Operating mode AUTOMATIC or RED. HEATING)
-  Standby heating circuit
-  Summer switch-off heating circuit
-  Frost protection heating circuit



Functions with direct access

4. Functions with direct access

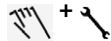
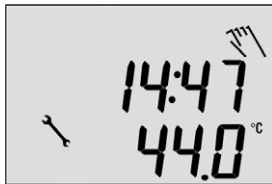
Manual operation



Controller is in manual mode

- Activate by pressing and holding  button
- end function by pressing  button

Function: Manual operation allows manual start-up of the heating circuit or measurement of emission without automatic functions. Manual operation has no influence on an activated Delta-T control.



- The heating circuit pump runs continuously
- The mixing valve is de-energised



Important!

This function shall only be used by an authorised professional. Heating circuit temperatures are not monitored during measurement of emission. Faulty operation or unsupervised operation of this function may result in damages to the heating system.

Adjustment room setpoint

Press buttons  and  in the basic display to directly set room day temperature. Such a variation changes the parameter 06:02 (see parameter description).

Menu level

5. Menu level

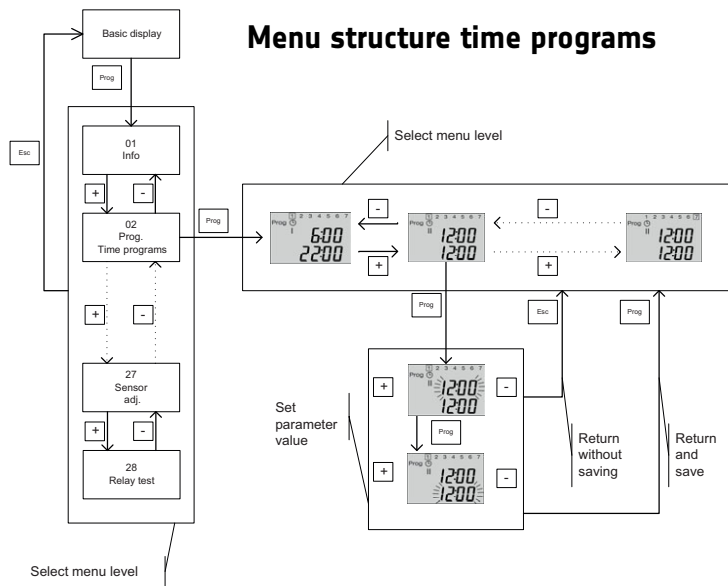
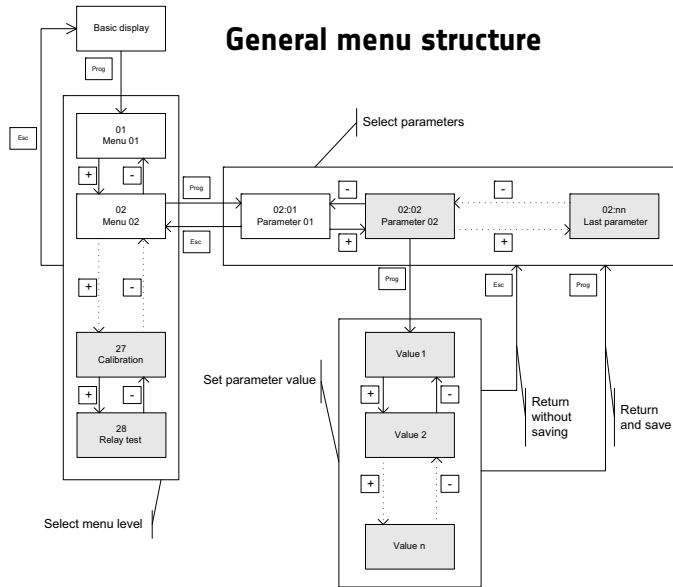

Menu level

Overview of menu level

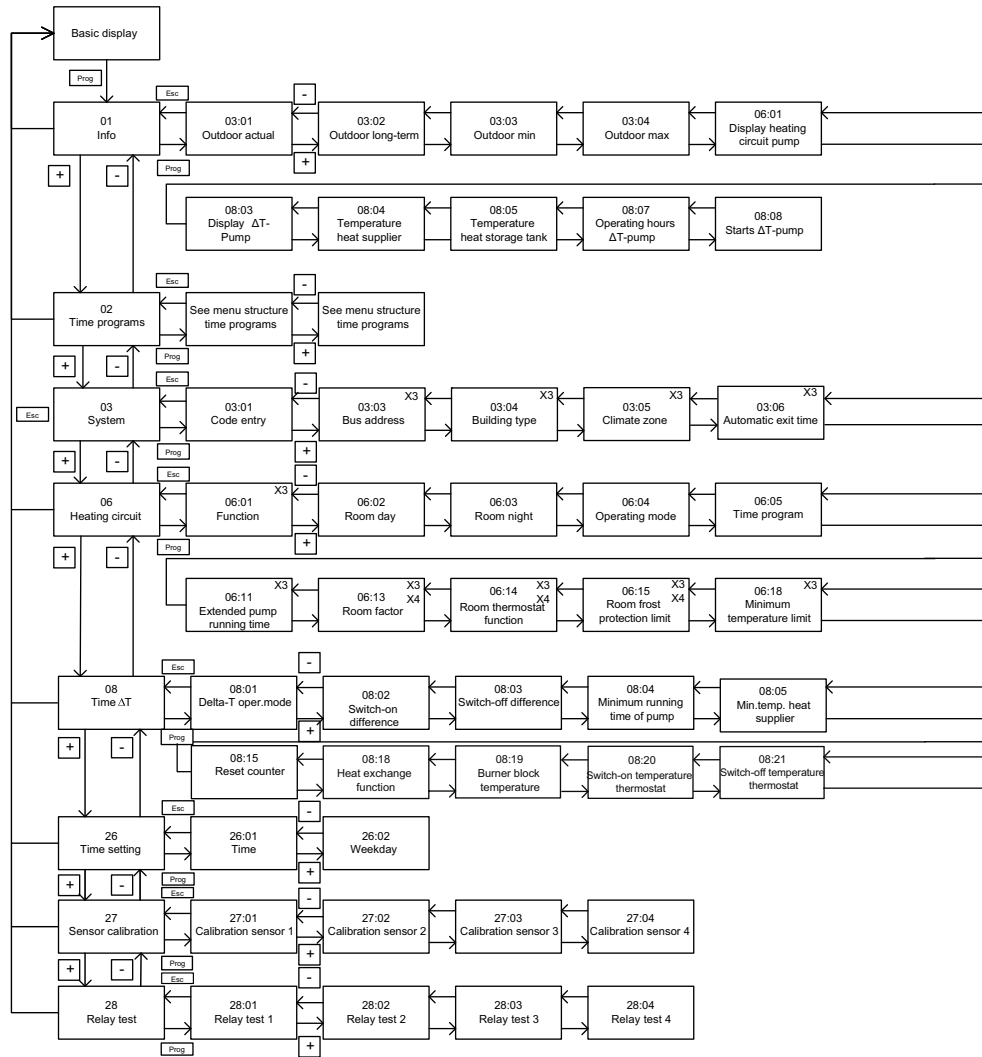

X2: Function only in bus connection

X3: Are hidden when activating code 03:09

X4: Only when connecting CETA RC



Menu level

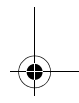
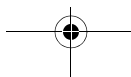
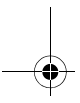
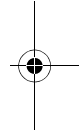
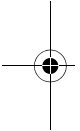
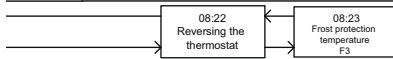
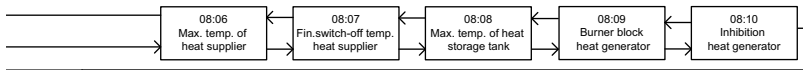
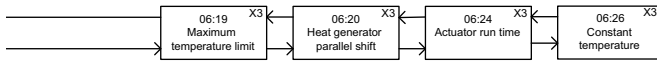
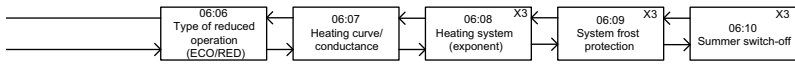
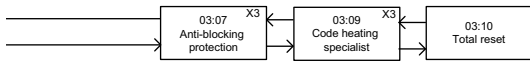
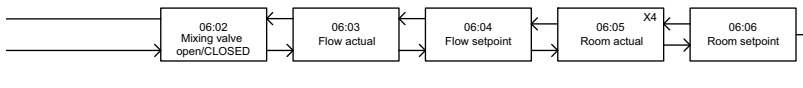

Parameter description

6. Parameter description**01 Information level**

Display	Designation	Description
03:01	Outdoor actual	Current outside temperature
03:02	Outdoor long-term	Average long-term value of outside temperature. Depending on set building type (03:04), the value is averaged longer or shorter.
03:03	Outdoor min	Minimum outside temperature value (0.00 to 24.00 h)
03:04	Outdoor max	Maximum outside temperature value (0.00 to 24.00 h)
06:01	Display heating circuit pump	0: Heating circuit pump is switched off 1: Heating circuit pump is switched on
06:02	Actuator heating circuit Open/Closed	0: Actuator (mixing valve) in idle position 1: Actuator runs open 2: Actuator runs closed
06:03	Flow heating circuit actual	Actual temperature on flow sensor of heating circuit F2
06:04	Flow heating circuit setpoint	Flow setpoint temperature for heating circuit
06:05	Room actual	Actual temperature in room X4
06:06	Room setpoint	Room setpoint temperature for heating circuit
08:03	Display ΔT -pump	0: Pump is switched off 1: Pump is switched on
08:04	Temperature heat supplier	Sensor temperature of heat supplier (e.g. collector, solid fuel boiler) at input F3
08:05	Temperature heat storage tank	Sensor temperature of heat storage tank at input F1
08:07	Operating hours ΔT -pump	Number of pump operating hours
08:08	Starts ΔT -pump	Number of pump starts

Parameter description

02 time programs

Weekday	Cycle of	Switch-on	Switch-off
1	I	06:00	22:00
1	II	12:00	12:00
2	I	06:00	22:00
2	II	12:00	12:00
3	I	06:00	22:00
3	II	12:00	12:00
4	I	06:00	22:00
4	II	12:00	12:00
5	I	06:00	22:00
5	II	12:00	12:00
6	I	06:00	22:00
6	II	12:00	12:00
7	I	06:00	22:00
7	II	12:00	12:00

Note: When switch-on and switch-off time are the same, cycle of operation is switched off.

Observe menu heating circuit parameter 06:05 (time program)!

03 Parameter system

Display	Designation	Description
03:01	Code entry	Setting range: 0 ... 999 Factory setting: 0 Function: Show parameters marked with X3 if they are hidden by the "Code heating specialist" 03:09.
03:03	Bus address	Setting range 31 ... 35 X3 Factory setting: 31 Function: If more than one CETA 106 has to be connected via data bus within a system, each unit must be set to a unique address.
03:04	Building type	Setting range: 1: light construction X3 (mean value over 6 hours) 2: Medium construction (mean value over 24 hours) 3: Heavy construction (mean value over 72 hours) Factory setting: 2 Function: This parameter considers the building type by adapting the calculation of the outside temperature mean value according to its setting.

Parameter description

Display	Designation	Description
03:05	Climate zone	Setting range: -50°C ... 0°C X3 Factory setting: -12°C Function: The climate zone is the coldest outside temperature value to be expected.
03:06	Automatic exit time	Setting range: 0,5 ... 10 Min X3 Factory setting: 2 min Function: When unit is not operated during the set time, the display returns to basic display.
03:07	Anti-blocking protection	Setting range: 0 = OFF X3 1 = ON Factory setting: OFF Function: With this function activated, pump is switched on daily for ca. 20 seconds as protection against blocking during extended switch-off phases > 24h).
03:09	Code heating specialist	Setting range: 0 ... 999 Factory setting: 0 Function when setting is greater than 0: Hide parameters marked with X3.
03:10	Total reset	Reset to factory settings

06 Parameter heating circuit

Display	Designation	Description
06:01	Function	Setting range: 0=OFF 1=Unmixed circuit 2=Mixed circuit 3=MC constant control Factory setting: 2
06:02	Room day	Setting range: 5 ... 30°C Factory setting: 20°C Function: The set temperature is the room setpoint during active cycles of operation in AUTOMATIC mode and during HEATING mode.
06:03	Room night	Setting range: 5 ... 30°C Factory setting: 16°C Function: The set temperature is the room setpoint between the cycles of operation in AUTOMATIC mode and during RED. HEATING mode.

Parameter description

Display	Designation	Description
06:04	Operating mode	<p>Setting range: 1: Automatic 2: Heating 3: Red. heating 4: Standby</p> <p>Factory setting: 1</p> <p>Function:</p> <p>Automatic: Heating circuit operates in Heating or Red. heating mode according to the time program assigned under 06:05</p> <p>Heating: Heating circuit operates continuously according to set room day temp. (06:02)</p> <p>Red. heating: Heating circuit operates continuously set room night temp. (06:03) under consideration of 06:06</p> <p>Standby: Frost-protected switch-off of heating circuit</p>
06:05	Time program	<p>Setting range: 1: Time program 1 2: Time program 2 3: Time program 1 and 2</p> <p>Factory setting: 1</p> <p>Function:</p> <p>Depending on the setting, the heating circuit operates according to time program 1, 2 or both, as set in menutree 02 (time programs).</p>
06:06	Type of reduced operation (ECO/RED)	<p>Setting range: 0: ECO 1: RED</p> <p>Factory setting: 0</p> <p>Function:</p> <p>The settings are effective in Reduced operating mode.</p> <p>ECO Frost-protected switch-off mode</p> <p>RED: Reduced mode</p>
06:07	Heating curve/ conductance	<p>Setting range: 0.05 ... 3.50</p> <p>Factory setting: 1.00</p> <p>Function:</p> <p>determines the heating curve for the heating circuit</p>

Parameter description

Display	Designation	Description
06:08	Heating system (Exponent)	<p>Setting range: 1.00...10.00 X3 Factory setting: 1,10 Function: Curvature of heating circuit's heating curve. Recommendation: 1,10: Underfloor heating or panel heating systems 1,30: Radiator heating 2,00: Convector and baseboard heating >3,00: General ventilator applications with high start temperatures</p>
06:09	Frost protection	<p>Setting range: OFF [----] X3 -50 °C ... +10 °C Factory setting: 3°C Function: To keep the heating system from freezing in switch-off mode, the controller is equipped with electronic frost protection. Caution: Faulty operation can result in damages to building!</p>
06:10	Summer switch-off	<p>Setting range: OFF [----] X3 10 °C ... 30 °C Factory setting: 20°C Function: Switch-off of heating operation at outside temperatures above the desired outside temperature.</p>

Parameter description

Display	Designation	Description
06:11	Extended pump running time	Setting range: 0.0...60.0 Min X3 Factory setting: 5 min Function: This function determines extended run time of heating circuit pump after heating circuit is switched off by time programs.
06:13	Room factor	Setting range: 0...500% X3, X4 Factory setting: 100% Function: This function determines to what extent a deviation of the room temperature from the setpoint affects the control of boiler flow temperature. Corrected room setpoint = set room setpoint - (deviation x room factor) / 100
06:14	Room thermostat function	Setting range: Off (---) X3, X4 0.5 ... 5K Factory setting: Off (---) Function: This function determines a room temperature limit; if limit is exceeded, heating is turned off.
06:15	Room frost protection limit	Setting range: 5...30°C X3, X4 Factory setting: 10°C Function: This function determines the room temperature during switch-off mode with activated frost-protection.
06:18	Minimum temperature limit	Setting range: 5 ... 95°C X3 Factory setting: 20°C Function: This function limits the flow temperature of the heating circuit. The set temperature will be maintained.
06:19	Maximum temperature limit	Setting range: 5 ... 95°C X3 Factory setting: 75°C Function: This function limits the flow temperature of the heating circuit. The set temperature will not be exceeded.
06:20	Heat generator parallel shift	Setting range: 0 ... 20K X3 Factory setting: 4K Function: The demand value of the heating circuit, plus the shift value, is transmitted to the heat generator.
06:24	Actuator run time	Setting range: 0...10 Min X3 Factory setting: 2 min Function: Use this setting to adjust the control characteristic of the mixing valve to the running time of the actuator in increments of 0.1 minutes (6 seconds).

Parameter description

Display	Designation	Description
06:26	Constant temperature	Setting range: 5 ... 95 °C Factory setting: 20 °C Function: Constant temperature to be controlled if designed as constant control.

08 Parameter Delta-T

Display	Designation	Description
08:01	Control mode	Setting range: 0 = Delta T OFF 1 = Delta T ON 3 = Thermostat: function only controls on F1. Factory setting: 0 Function: The setting can be used to switch the differential control on or off or to thermostat function.
08:02	Switch-on difference	Setting range: (switch-off difference + 3K) ... 30K Factory setting: 10K Function: If the temperature difference between the sensors of heat supplier F3 and heat storage tank F1 exceeds the set value, the pump turns on.
08:03	Switch-off difference	Setting range: 2K ... (Switch-on differential -3 K) Factory setting: 5K Function: If the temperature difference between the sensors of heat supplier F3 and heat storage tank F1 drops below the set value, the pump turns off.
08:04	Minimum running time of pump	Setting range: OFF [----] 0.5 ... 60 min Factory setting: 3 min Function: Minimum switch-on time of pump per start.
08:05	Minimum temperature heat supplier	Setting range: OFF [----] 5 ... 80 °C Factory setting: OFF Function: Irrespective of switching differentials, the pump switches on only after the sensor of heat supplier F3 has exceeded the set value. Note: The set minimum temperature has a fixed switching hysteresis of 10K!
08:06	Maximum temperature heat supplier	Setting range: OFF [----] 30 ... 110 °C Factory setting: 90°C Function: Irrespective of switching differentials, the pump performs a forced switch on after the sensor of heat supplier F3 has exceeded the set value.

Parameter description

Display	Designation	Description
08:07	Final switch-off temperature Heat supplier	Setting range: OFF [----] 70 ... 210 °C Factory setting: OFF Function: Irrespective of switching differentials, the pump performs a forced switch off after the sensor of heat supplier F3 has exceeded the set value.
08:08	Maximum temperature heat storage tank	Setting range: OFF [----] 50 ... 110 °C Factory setting: 75°C Function: Irrespective of switching differentials, the pump performs a forced switch off after the sensor of heat storage tank F1 has exceeded the set value. This switch-off takes priority over functions 08:07 and 08:06.
08:09	Burner block Heat generator	Setting range: 0 ... 2 Factory setting: 1 Function: 0 = OFF 1 = Burner block when pump is active 2 = Burner block only for DHW when pump is active
08:10	Inhibition heat generator	Setting range: OFF [----] ... 24h Function: After burner block is active, the heat generator is also blocked for the duration of the set time
08:15	Reset counter	Setting range: 0 = no reset 1 = Reset counter Factory setting: 0 Function: When value is changed to 1 and confirmed, all counters (heat balance, operating hours and starts) are reset.
08:18	Heat exchange difference	Setting range: OFF [----], 5 ... 50K Factory setting: OFF Function: If the F1 temperature is higher than 08:08 and the F3 temperature below 40°C, the pump will be switched on until the F1 is lowered to the set difference below 08:08.
08:19	Burner block temperature	Setting range: OFF [----], 5 ... 80 °C Factory setting: OFF Function: Additionally or alternatively to 08:09, an F1 temperature can be set whereby the burner block will be activated (via data bus). When the temperature sinks below the value of 08:19 by 5K, it will be deactivated.

Parameter description

Display	Designation	Description
08:20	Switch-on temperature thermostat	Setting range: 5 °C ... (switch-off temperature -3K) Factory setting: 30 °C Function: If F1 sinks below the set value, the ΔT_1 pump switches on.
08:21	Switch-off temperature thermostat	Setting range: (switch-on temperature +3K) ... 120 °C Factory setting: 90 °C Function: If F1 exceeds the set value, the ΔT_1 pump switches off.
08:22	Reversing the thermostat	Setting range: 0, 1 Factory setting: 0 Function: reverts the pump function. 0 = NO contact, 1 = NC contact
08:23	Frost protection temperature of sensor F3	Setting range: OFF, -15 °C ... 10 °C Factory setting: OFF Function: When the F3 temperature is below the set value, the ΔT_1 pump will be switched on, and it will be switched off when the F3 temperature exceeds the set value by +2.5K.

26 Time setting

Display	Designation	Description
26:01	Time	Setting range: 00:00 ... 23:59 Factory setting: Current time Function: Setting of current time.
26:02	Weekday	Setting range: 1 ... 7 Factory setting: Current weekday Function: Setting of current weekday.

27 Sensor calibration

Display	Designation	Description
27:01	Calibration F1	Setting range: -5K ... +5K Factory setting: 0K Function: Correction of measured sensor value at input of heat storage tank F1
27:02	Calibration F2	See 27:01 on input flow sensor heating circuit
27:03	Calibration F3	See 27:01 on input heat supplier Delta-T
27:04	Calibration F4	See 27:01 on input outside sensor

Mounting

28 Relay test

Display	Designation	Description
28:01	Test output 1	Setting range: 0 = OFF 1 = ON Factory setting: 0 Function: By changing the value, the output switches heat circuit pump on and off (test function), independent of function.
28:02	Test output 2 (mixing valve open)	See 28:01 for mixing valve output open
28:03	Test output 3 (mixing valve closed)	See 28:01 for mixing valve output closed
28:04	Test output 4 (charge pump Delta-T)	See 28:01 on input charge pump Delta-T

7. Mounting



Hazard!

Installation must be performed only by an authorised professional electrician! Ensure that unit is de-energised before opening it!

Drilling pattern for wall fastening

1. Remove terminal area cover from casing.
2. For mounting, first put a screw into the wall.
3. Hang controller into the opening.
4. Use controller as template for the other screw holes.

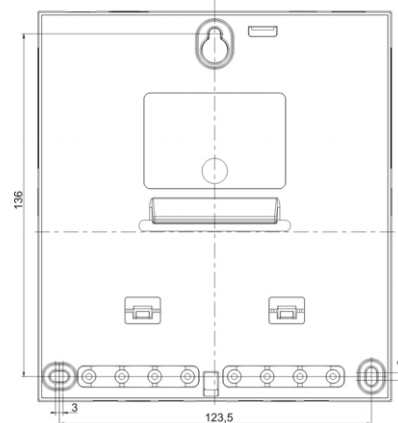

Terminal diagram

Rail mount

1. Insert mounting feet into rail mount opening.
2. Lock hook in place by pushing down.

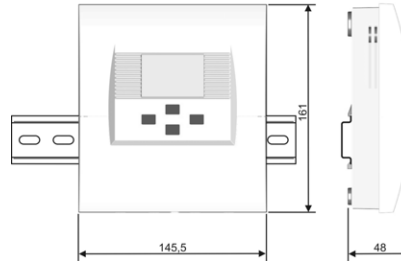

8. Terminal diagram



Hazard!

Connection must be performed only by an authorised professional electrician! Ensure that unit is de-energised before opening it!

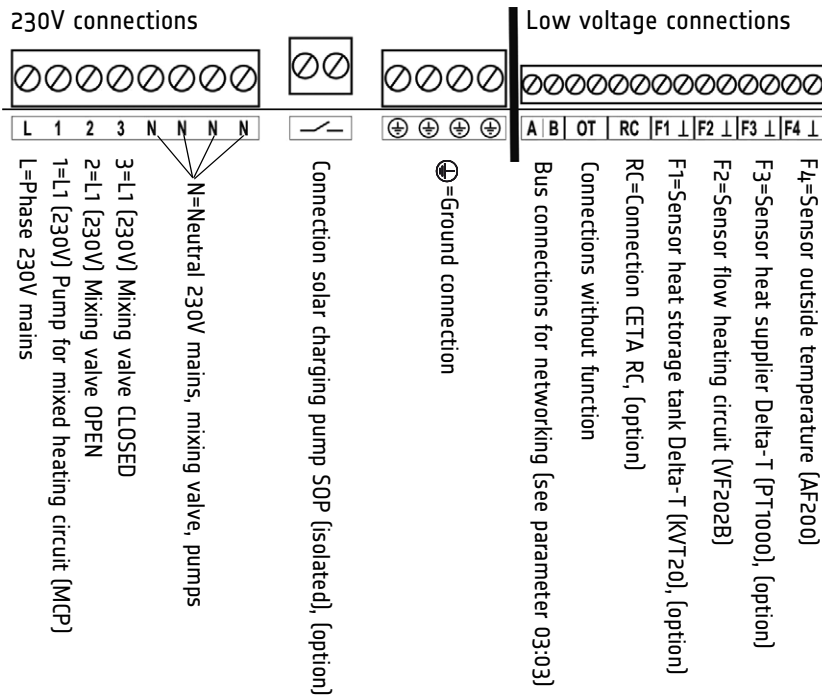

Fault clearance

9. Fault clearance

To allow an accurate diagnosis in case of malfunction, the unit is equipped with a fault display system. The faults are shown on the basic display of the unit in form of an error code.

Fault overview:

Fault code	Cause	Repair
11-0	Interruption sensor F1	Check cable and plug connection; replace if necessary
11-1	Short circuit sensor F1	Replace tank sensor
12-0	Interruption sensor F2	See 11-0
12-1	Short circuit sensor F2	See 11-1
13-0	Interruption sensor F3	See 11-0
13-1	Short circuit sensor F3	See 11-1
14-0	Interruption sensor F4	See 11-0
14-1	Short circuit sensor F4	See 11-1
72-6	Data bus CETA RC no signal (terminal RC)	Repair malfunction on data bus to room unit CETA RC
73-2	Device bus address collision (Terminal AB)	Set controls of the same type to different bus addresses (parameter 03:03)
73-6, 74-0 to 74-9	Unit bus error communication (Terminal AB)	Check bus connection between the units

Sensor resistance values

10. Sensor resistance values

Depending on temperature:

PT1000 (option)

T (°C)	R (kOhm)
40	1,155
50	1,194
60	1,232
70	1,271
80	1,309
90	1,347
100	1,385
110	1,423
120	1,461
130	1,498
140	1,536
150	1,573
160	1,611
170	1,648
180	1,685
190	1,722
200	1,758
210	1,795
220	1,832
230	1,868
240	1,905
250	1,941

VF202B, AF200, KVT20 (option)

T (°C)	R (kOhm)
10	1,783
12	1,812
14	1,840
16	1,869
18	1,898
20	1,928
25	2,002
30	2,078
35	2,155
40	2,234
45	2,314
50	2,395
55	2,478
60	2,563
65	2,648
70	2,735
75	2,824
80	2,914
85	3,005
90	3,098
95	3,192
100	3,287



Technical Data

12. Technical Data

Power supply voltage:	230V +6%/ -10%
Rated frequency:	50...60Hz
Power input:	max. 2.1VA
Fuse:	6.3A
Output relay contact load:	2 (2)A
Ambient temperature:	-10...+50°C
Storage temperature:	-25...+80°C
Degree of protection:	IP 30
Protection class according to EN 60730:	II
CE compliance:	89/336/EEC
Casing dimensions:	145.5 x 161 x 48 mm (W x H x D)
Casing material:	ABS V0
Weight:	420g
Mains connection technology:	Screw terminals 1.5 mm ²
Sensor connection technology:	Screw terminals 1.0 mm ²

13. Liability

Our general terms and conditions of business are generally applicable. Any liability claims based on failure to observe operating manual as well as safety instructions contained therein, are excluded. Subject to technical modifications.

14. Disposal

Dispose of all replaced parts, and eventually the controller itself, in an environmentally sound manner in compliance with applicable statutory regulations of the corresponding country.

Company stamp:

