

Operating manual

CETA 100

Differential temperature control

Version 1308-22
Art. 0450021014

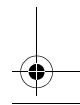
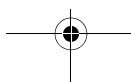
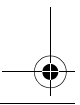



Contents

Scope of delivery	1
General	1
Intended use	1
Safety	1
General key functions	2
Version display (when starting)	2
Basic display	2
Function with direct access	3
Sensor resistance values	4
Menu level	5
Parameter description	8
Mounting	13
Terminal diagram	14
Fault clearance	15
Declaration of conformity	16
Technical Data	17
Liability	17
Disposal	17

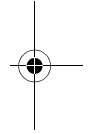
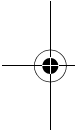

© Elektronikbau- und Vertriebs GmbH

Heisterner Weg 8 - 12

D-57299 Burbach

This document may not be reproduced nor disclosed to third parties, particularly competitors, in original or copy form without our prior explicit consent. The document is subject to our proprietary rights and copyrights.

Any misuse is an infringement of the German Copyright Law of September 9, 1965, the law against unfair competition, and the German Civil Code.

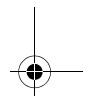
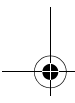



Scope of delivery

1. 1x Central unit CETA 100
2. 1x Tank immersion sensor KVT 20/2/6
3. 1x Collector sensor PT1000/6
4. 8x Screw, plate 2,9x19 mm
5. 3x Screw assembly 4x35 mm
6. 3x Plug U6
7. 2 x Cable clamp

General

Systems with heat source and hot water tank are controlled via the differential temperature control. When the heat source temperature exceeds the tank temperature by the value set on the controller, the circulation pump is activated by the control and the heat absorbed in the heat source is transported to the hot water tank.

Intended use

The unit is manufactured in accordance with state of the art technology and approved safety regulations. Nevertheless, using the unit can cause danger to the user or third persons, or damage to the unit and other assets. The unit must be used exclusively as differential temperature controller.

Safety

All electrical connections, safety measures and protections have to be carried out by an authorised professional electrician according to the valid standards and VDE-guidelines, as well as the local regulations. The electrical connection must be a fixed connection according to VDE 0100.

Hazard symbols in this operating manual



Hazard!

This symbol indicates information that warns of possible safety risks or severe and fatal injuries!



General key functions

1. General key functions

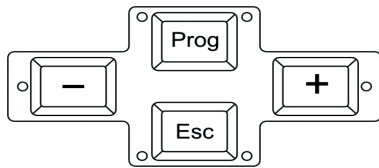

Prog

- Change selected submenus
- Change (parameter) setting
- Save value

+ (Plus) or - (Minus)

- Change parameter
- Change menu item

Esc

- Exit setting
- Keep old value
- Select next higher menu level

Esc-Lang

- Return to basic display

2. Version display (when starting)

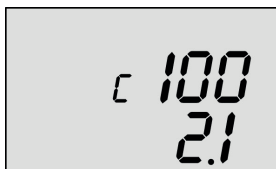

c 100= Type designation

2.1= Version display (due to update it can differ from example shown)

3. Basic display

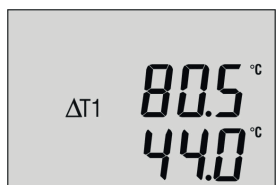

80.5°C= Temperature heat supplier (e.g. collector or solid fuel boiler)

44.0°C= Temperature heat storage tank

ΔT1= Display pump function

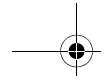



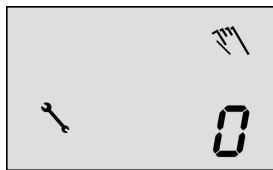

Function with direct access

4. Function with direct access

Manual operation



Controller is in manual mode
Pump function

- Activate by pressing and holding  button
- Change pump function via buttons  and 
- end function by pressing  button

Function: Manual operation allows manual start-up of the system, e.g. to perform venting.
0 = The pump $\Delta T1$ is OFF.

1 = The pump $\Delta T1$ runs continuously.



Important!
This function shall only be used by an authorised professional. Temperatures are not monitored during manual operation. Faulty operation or unsupervised operation of this function may result in damages to the heating system.

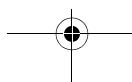



Sensor resistance values



5. Sensor resistance values

Depending on temperature:

PT1000

T (°C)	R (kOhm)
40	1,155
50	1,194
60	1,232
70	1,271
80	1,309
90	1,347
100	1,385
110	1,423
120	1,461
130	1,498
140	1,536
150	1,573
160	1,611
170	1,648
180	1,685
190	1,722
200	1,758
210	1,795
220	1,832
230	1,868
240	1,905
250	1,941

KVT 20

T (°C)	R (kOhm)
10	1,783
12	1,812
14	1,840
16	1,869
18	1,898
20	1,928
25	2,002
30	2,078
35	2,155
40	2,234
45	2,314
50	2,395
55	2,478
60	2,563
65	2,648
70	2,735
75	2,824
80	2,914
85	3,005
90	3,098
95	3,192
100	3,287

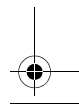
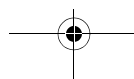
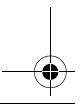
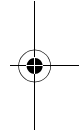
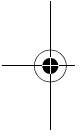

Menu level

6. Menu level

General menu structure Ceta series

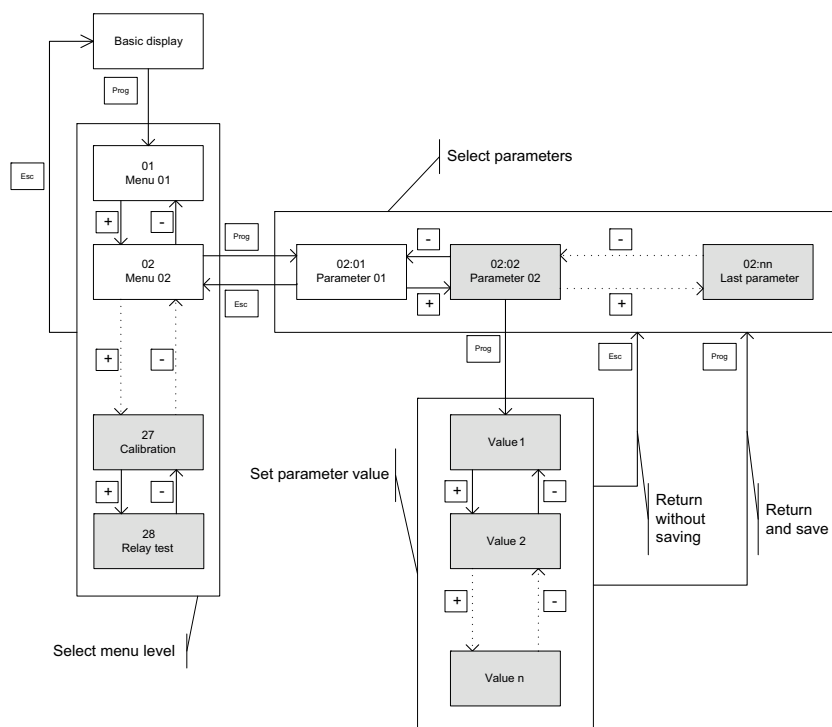

Menu level

Overview of menu level

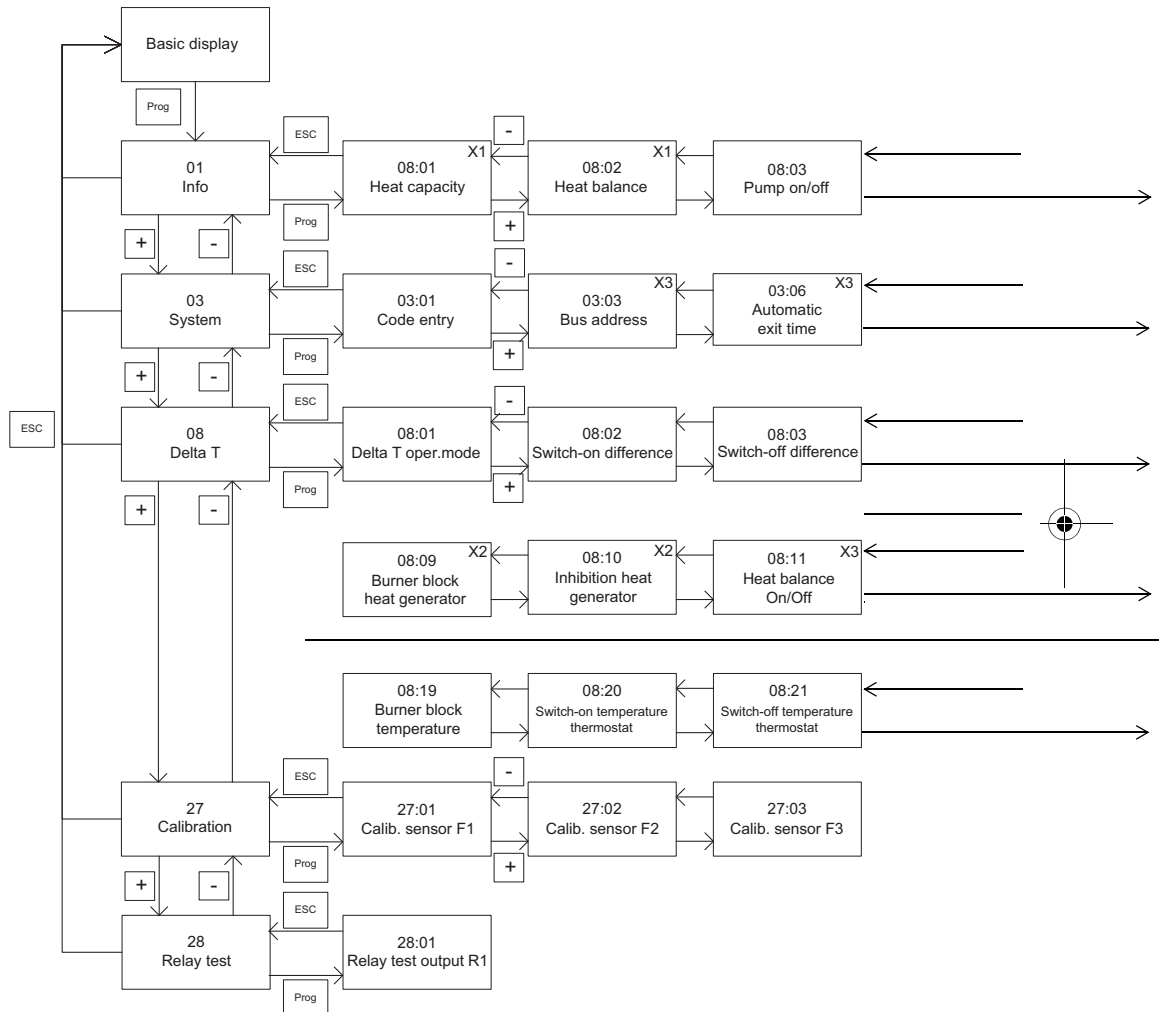

X1: Only displayed during active heat balancing

X2: Function only in bus connection

X3: Are hidden when activating code 03:09

Menu level

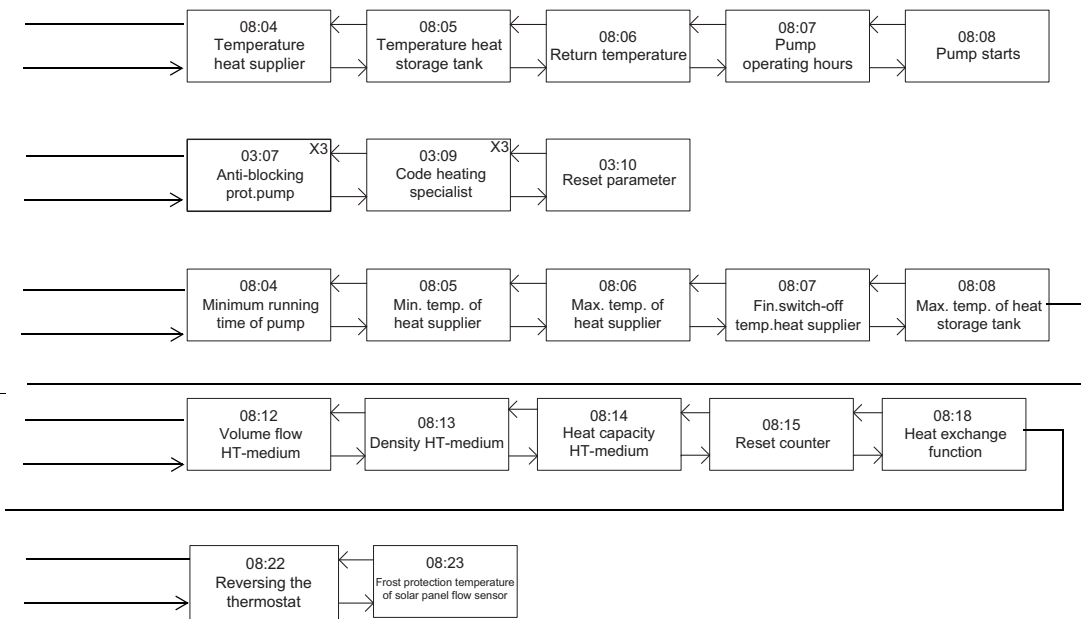

Parameter description

7. Parameter description

01 Information level

Display	Designation	Description
08:01	Heat capacity	Current heat capacity in W X1
08:02	Heat balance	Display of cumulative heat energy in kWh X1
08:03	Display pump function	0: Pump is switched off 1: Pump is switched on
08:04	Temperature Heat supplier	Sensor temperature of heat supplier (e.g. collector, solid fuel boiler) at input F3
08:05	Temperature Heat storage tank	Sensor temperature of heat storage tank at input F1
08:06	Return temperature	Sensor temperature of return at input F2, if available.
08:07	Pump operating hours	Number of pump operating hours
08:08	Pump starts	Number of pump starts

03 Parameter system

Display	Designation	Description
03:01	Code entry	Setting range: 0 ... 999 Factory setting: 0 Function: Show parameters marked with X3 if they are hidden by the "Code heating specialist" 03:09.
03:03	Bus address	Setting range: 21...25 X3 Factory setting: 21 Function: If more than one CETA 100 or 101 has to be connected via data bus within a system, each unit must be set to a unique address.
03:06	Automatic exit time	Setting range: 0.5 ... 10 min X3 Factory setting: 2 min Function: When unit is not operated during the set time, the display returns to basic display.
03:07	Anti-blocking protection	Setting range: 0 = OFF X3 1 = ON Factory setting: OFF Function: Pump is switched on 20 s daily during extended shutdown (> 24h) as protection against blocking when function is activated.

Parameter description

Display	Designation	Description
03:09	Code heating specialist	Setting range: 0 ... 999 Factory setting: 0 Function: Hide parameters marked with X3.
03:10	Total reset	Reset to factory settings

08 Parameter Delta-T

Display	Designation	Description
08:01	Control mode	Setting range: 0...3 Factory setting: 1 Function: 0 = OFF 1 = Delta-T without return flow sensor 2 = Delta-T with return flow sensor F2 3 = Thermostat function F1
08:02	Switch-on difference	Setting range: (Switch-off differential + 3K) ... 30K Factory setting: 10K Function: If temperate difference between sensors of heat supplier F3 and heat storage tank F1 is greater than set value, the pump switches on .
08:03	Switch-off difference	Setting range: 2K ... (Switch-on differential - 3K) Factory setting: 5K Function: If temperate difference between sensors of heat supplier F3 and heat storage tank F1 is less than set value, the pump switches off .
08:04	Minimum running time of pump	Setting range: OFF (---) 0.5 ... 60 min Factory setting: 3 min Function: Minimum switch-on time of pump per start.
08:05	Minimum temperature heat supplier	Setting range: OFF (---) 5 ... 80 °C Factory setting: OFF Function: Irrespective of switching differentials, the pump switches on only after the sensor of heat supplier F3 has exceeded the set value. Note: The set minimum temperature has a fixed switching hysteresis of 10K.

Parameter description

Display	Designation	Description
08:06	Maximum temperature heat supplier	Setting range: OFF [----], 30 ... 110 °C Factory setting: 90°C Function: Irrespective of switching differentials, the pump performs a forced switch on after the sensor of heat supplier F3 has exceeded the set value.
08:07	Final switch-off temperature of heat supplier	Setting range: OFF [----], 70 ... 210 °C Factory setting: OFF Function: Irrespective of switching differentials, the pump performs a forced switch off after the sensor of heat supplier F3 has exceeded the set value.
08:08	Maximum temperature heat storage tank	Setting range: OFF [----], 50 ... 110 °C Factory setting: 75°C Function: Irrespective of switching differentials, the pump performs a forced switch off after the sensor of heat storage tank F1 has exceeded the set value. This switch-off takes priority over functions 08:07 and 08:06.
08:09	Burner block Heat generator	Setting range: 0 ... 2 X2 Factory setting: 1 Function: 0 = OFF 1 = Burner block when pump is active 2 = Burner block only for DHW when pump is active
08:10	Temporary interruption of heat generator	Setting range: OFF [----] ... 24h X2 Factory setting: OFF Function: After burner block is active, the heat generator is also blocked for the duration of the set time.
08:11	Activation of heat balance	Setting range: OFF [----] X3 1 = Heat balancing via sensor on F2 Factory setting: 1 Function: The settings of parameters 08:12 to 08:14 are only active if the heat balance function has been switched on via this parameter.
08:12	Volume flow HT-medium	Setting range: 0.0 ... 30 l/min Factory setting: 0.0 l/min Function: Here the volume flow is set in litre/minute when calculating flow rate, according to respective pump capacity.

Parameter description

Display	Designation	Description
08:13	Density HT-medium	Setting range: 0.8 ... 1.2 kg/l Factory setting: 1.05 kg/l Function: Using this parameter, the density of the heat transfer medium is entered in kilogramme per litre, according to manufacturer's data.
08:14	Heat capacity HT-medium	Setting range: 2.0 ... 5.0 kJ/kgK Factory setting: 3.6 kJ/kgK Function: This setting value is used to enter the specific heat capacity of the heat transfer medium according to manufacturer's information.
08:15	Reset counter	Setting range: 0 = no reset, 1 = reset counter Factory setting: 0 Function: When value is changed to 1 and confirmed, all counters (heat balance, operating hours and starts) are reset.
08:18	Heat exchange difference	Setting range: OFF (---), 5 ... 50K Factory setting: OFF Function: If the F1 temperature is higher than 08:08 and the F3 temperature below 40°C, the pump will be switched on until the F1 is lowered to the set difference below 08:08.
08:19	Burner block temperature	Setting range: OFF (---), 5 ... 80 °C Factory setting: OFF Function: Additionally or alternatively to 08:09, an F1 temperature can be set whereby the burner block will be activated (via data bus). When the temperature sinks below the value of 08:19 by 5K, it will be deactivated.
08:20	Switch-on temperature thermostat	Setting range: 5 °C ... (switch-off temperature -3K) Factory setting: 30 °C Function: If F1 sinks below the setting range, the pump switches on.
08:21	Switch-off temperature thermostat	Setting range: (switch-on temperature +3K) ... 120 °C Factory setting: 90 °C Function: If F1 exceeds the set value, the pump switches off.
08:22	Reversing the thermostat	Setting range: 0, 1 Factory setting: 0 Function: reverts the pump function. 0 = closer, 1 = opener



Parameter description



Display	Designation	Description
08:23	Frost protection temperature of solar panel flow sensor	Setting range: OFF, -15 °C ... 10 °C Factory setting: OFF Function: When the solar panel temperature is below the set value, the solar loading pump will be switched on, and it will be switched off when the solar panel temperature exceeds the set value by +2.5K.

27 Sensor calibration

Display	Designation	Description
27:01	Calibration F1	Setting range: -5K ... +5K Factory setting: 0K Function: Correction of measured sensor value on Input heat storage tank F1
27:02	Calibration F2	See 27:01 on input return F2
27:03	Calibration F3	See 27:01 on input heat supplier F3

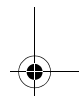
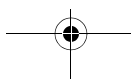
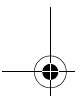
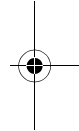
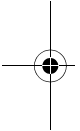

Mounting

28 Relay test

Display	Designation	Description
28:01	Test pump output	Setting range: -0 = OFF 1 = ON Factory setting: 0 Function: By changing the value, the output switches on and off (test function), independent of function.

8. Mounting



Hazard!
Installation must be performed only by an authorised professional electrician! Ensure that unit is de-energised before opening it!

Drilling pattern for wall fastening

1. Remove terminal area cover from casing.
2. For mounting, first put a screw into the wall.
3. Hang controller into the opening.
4. Use controller as template for the other screw holes.

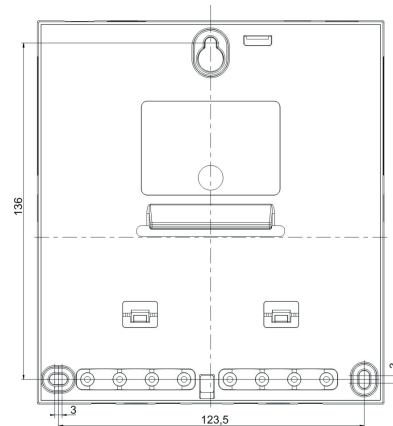

Rail mount

1. Insert mounting feet into rail mount opening.
2. Lock hook in place by pushing down.

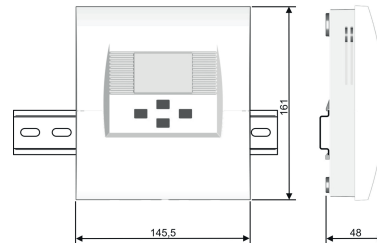

Terminal diagram

9. Terminal diagram



Hazard!
Connection must be performed only by an authorised professional electrician! Ensure that unit is de-energised before opening it!

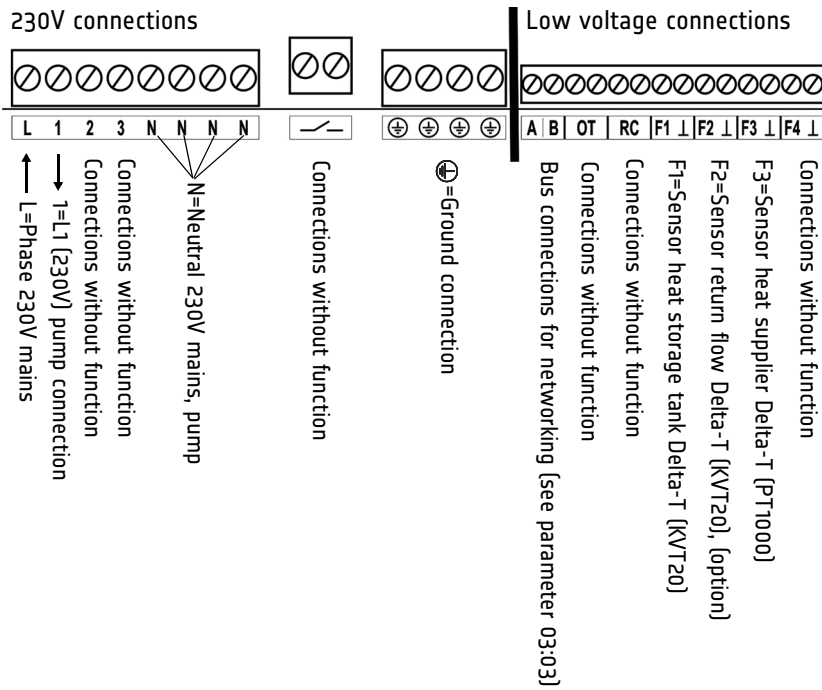

Fault clearance

10. Fault clearance

To allow an accurate diagnosis in case of malfunction, the unit is equipped with a fault display system. The faults are shown on the basic display of the unit in form of an error code:

0---°C = Sensor heat supplier (e.g. collector or solid fuel boiler) has interruption

1---°C = Sensor heat storage tank has short circuit

1---°C = Sensor heat supplier (e.g. collector or solid fuel boiler) has short circuit

0---°C = Sensor heat storage tank has interruption



Fault overview:

Fault code	Cause	Repair
0---	Sensor F1, F2 or F3 interruption	Check cable and plug connection; repair if necessary
1---	Sensor F1, F2 or F3 short circuit	Replace sensor
Fault	Cause	Repair
Display text not visible	No power, defective fuse in unit	Check cable and plug connection; repair if necessary; replace fuse

A corresponding fault code is shown alternately in the lower display:

Fault	Cause	Repair
11-0	Interruption sensor F1	Check cable and plug connection; replace if necessary
11-1	Short circuit sensor F1	Replace tank sensor
12-0	Interruption sensor F2	See 11-0
12-1	Short circuit sensor F2	See 11-1
13-0	Interruption sensor F3	See 11-0
13-1	Short circuit sensor F3	See 11-1

Declaration of conformity

11. Declaration of conformity



Elektronikbau- und Vertriebs- GmbH
Heisternerweg 8-12, 57299 Burbach

EC Declaration of Conformity



Product identification: Heating controller

Type designation: CETA 100

**Manufacturer: EbV Elektronikbau- und Vertriebs-GmbH
Heisternerweg 8-12
57299 Burbach**

The product described is in full compliance with the following European directives:

89/336/EEC „Council directive on the approximation of the laws of the member states relating to Electromagnetic Compatibility“

73/23/EEC „Council directive on the approximation of the laws of the member states relating to electrical equipment designed for use within certain voltage limits“ (low voltage directive)

Compliance of the designated product with the rules of the directive is proven by complete adherence to the following standards:

EMV: Requirements for household appliances, electric tools and similar devices
DIN EN 55014-1:2003 Part 1: Transient emission
DIN EN 55014-2:2002 Part 2: Immunity

EMV: Limit values
DIN EN 61000-3-2:2002 Part 3-2: Limit values for harmonic current emissions
DIN EN 61000-3-3:2002 Part 3-3: Limitation of voltage fluctuations and flicker

Automatic electrical controls for household use and similar applications
DIN EN 60730-1:2002 Part 1: General requirements
DIN EN 60730-2-9:2004 Part 2: Particular requirements for temperature sensing controls

We declare that the described product - as independent device - is in conformity with the standards, directives and/or technical specifications listed above.

EbV Elektronikbau- und
Vertriebs-GmbH

Burbach, 20.02.2009

Wolfgang Höse
Managing Director

Technical Data

12. Technical Data

Power supply voltage:	230V +6% / -10%
Rated frequency:	50...60Hz
Power input:	max. 2.1VA
Fuse:	6.3A
Output relay contact load:	2 (2)A
Ambient temperature:	-10...+50°C
Storage temperature:	-25...+80°C
Degree of protection:	IP 30
Protection class according to EN 60730:	II
CE compliance:	89/336/EEC
Casing dimensions:	145.5 x 161 x 48 mm (W x H x D)
Casing material:	ABS V0
Weight:	420g
Mains connection technology:	Screw terminals 1.5 mm ²
Sensor connection technology:	Screw terminals 1.0 mm ²

13. Liability

Our general terms and conditions of business are generally applicable. Any liability claims based on failure to observe operating manual as well as safety instructions contained therein, are excluded. Subject to technical modifications.

14. Disposal

Dispose of all replaced parts, and eventually the controller itself, in an environmentally sound manner in compliance with applicable statutory regulations of the corresponding country.

Company stamp: